

Operating Instructions

DV Mini DV NTSC

**PRO
LINE**

AG-DV2000P

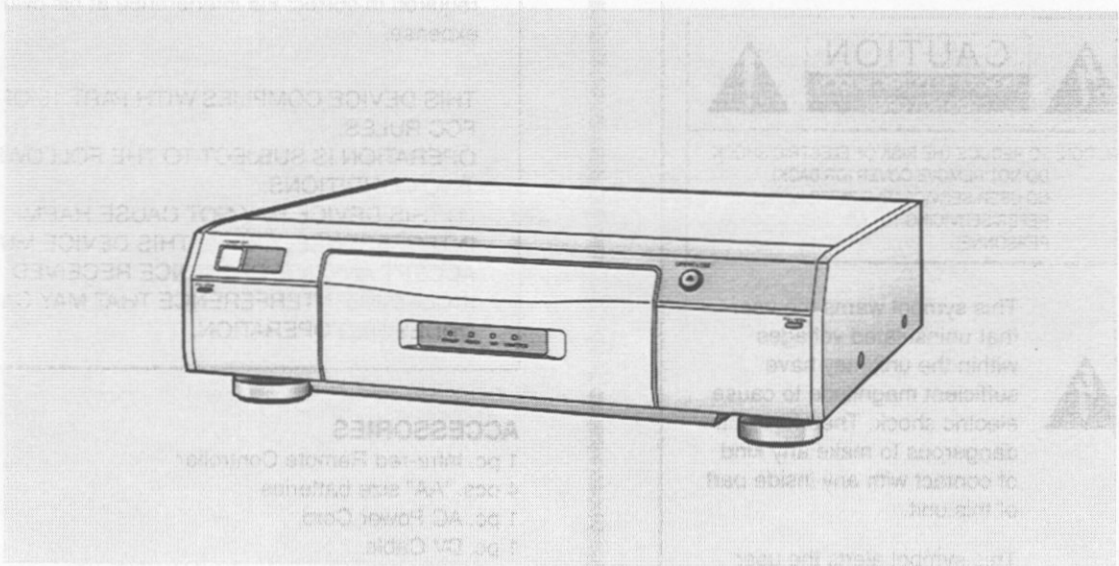

Panasonic
Professional/Industrial Video

Digital Video Cassette Recorder

Before attempting to connect, operate or adjust this product, please read these instructions completely.

Dear Customer

Thank you for purchasing this Panasonic Digital Video Cassette Recorder.

We recommend that you carefully study the Operating Instructions before attempting to operate the unit and that you note the listed precautions.

WARNING:
TO REDUCE THE RISK OF FIRE OR SHOCK HAZARD, DO NOT EXPOSE THIS EQUIPMENT TO RAIN OR MOISTURE.

CAUTION:

- TO REDUCE THE RISK OF FIRE, SHOCK HAZARD AND ANNOYING INTERFERENCE, USE THE RECOMMENDED ACCESSORIES ONLY.
- DO NOT BLOCK ANY OF THE VENTILATION OPENINGS. INSTALL IN ACCORDANCE WITH THE MANUFACTURER'S INSTRUCTIONS.
- DO NOT PLACE THIS APPARATUS INTO AN AUDIO RACK, BOOK SHELF OR SIMILAR LOCATION BECAUSE OF HEAT FROM THIS APPARATUS.



CAUTION: TO REDUCE THE RISK OF ELECTRIC SHOCK, DO NOT REMOVE COVER (OR BACK). NO USER-SERVICEABLE PARTS INSIDE. REFER SERVICING TO QUALIFIED SERVICE PERSONNEL.



This symbol warns the user that uninsulated voltages within the unit may have sufficient magnitude to cause electric shock. Therefore, it is dangerous to make any kind of contact with any inside part of this unit.



This symbol alerts the user that important literature concerning the operation and maintenance of this unit has been included. Therefore, it should be read carefully in order to avoid any problems.

FCC NOTE:

FCC Caution: To assure continued compliance, follow the attached installation instructions and use only shielded cables when connecting to other devices. Also, any changes or modifications not expressly approved by the party responsible for compliance could void the user's authority to operate this equipment.

This equipment has been tested and found to comply with the limits for a Class A digital device, pursuant to Part 15 of the FCC Rules. These limits are designed to provide reasonable protection against harmful interference when the equipment is operated in a commercial environment. This equipment generates, uses and can radiate radio frequency energy and, if not installed and used in accordance with the instruction manual, may cause harmful interference to radio communications. Operation of this equipment in a residential area is likely to cause harmful interference in which case the user will be required to correct the interference at his own expense.

THIS DEVICE COMPLIES WITH PART 15 OF THE FCC RULES.

OPERATION IS SUBJECT TO THE FOLLOWING TWO CONDITIONS:

(1) THIS DEVICE MAY NOT CAUSE HARMFUL INTERFERENCE, AND (2) THIS DEVICE MUST ACCEPT ANY INTERFERENCE RECEIVED, INCLUDING INTERFERENCE THAT MAY CAUSE UNDESIRE OPERATION.

ACCESSORIES

- 1 pc. Infra-red Remote Controller
- 4 pcs. "AA" size batteries
- 1 pc. AC Power Cord
- 1 pc. DV Cable
- 1 pc. Edit Cable
- 1 pc. S-Video Cable
- 1 pc. AV Cables
- 1 pc. Editing Controller Cable
- 1 pc. Digital Video Head Cleaner

Attached Parts:

- 1 pc. Modular Cap

Contents

Before Use

Controls and Connection Sockets	4
Infra-red Remote Controller	7
Editing Controller	9
Remote Controller Setup	11
Editing Controller Setup	11
Connections	13
Inserting the Cassette	13

Basic Operations

Playback	14
• Other Playback Functions	15
Manual Recording	16

Advanced Operations

Search Functions	17
• Index Search System	17
• Photoshot Index Search System	17

Various Settings

Setting the Clock of Your VCR	18
Settings Using On Screen Display	19

Preparations for Editing

Editing Functions	22
Connecting with a Digital Video Camera	24
Connecting Two Digital Video Cassette Recorders (Using Two AG-DV2000)	26
Connecting an S-VHS (VHS) VCR with an Edit Socket	28
Initial Settings for Editing	30
Creating the Tapes For Editing	33

For Quick Editing

Editing when Not Using an Edit Cable	34
One-Touch Assemble	36
One-Touch Insert/Audio Dubbing	38
One-Touch Audio Mixing	40
Manual Copying	42
Manual Insert	44
Manual Audio Dubbing	46

Program Editing

Program Assemble	48
Program Insert	52
Program Audio Dubbing	56
Other Editing Functions	60

Helpful Hints

Edit Timing Adjustment	62
• Program Editing	62
• Manual Editing	64
Glossary of Terms	65
On Screen Display Messages	67
Before Requesting Service	68
Flow Chart for On Screen Display	70
Usage Precautions	74

Specifications	76
----------------------	----

Control and Connection Sockets

This section gives a detailed explanation of the function of each button, switch and connection socket

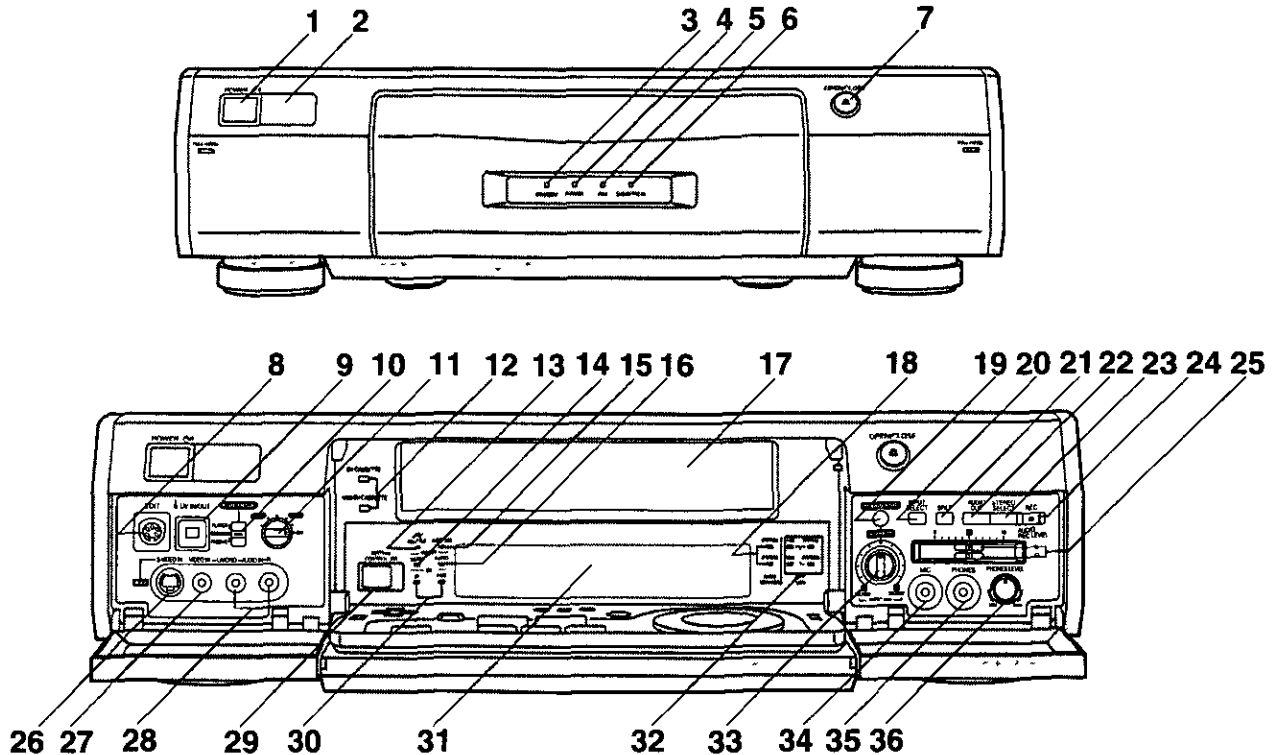

FRONT

- 1 POWER**

Press to switch the VCR from on to standby mode or vice versa. In standby mode, the unit is still connected to the mains.
- 2 Infra-red Remote Control Receiver Window**
- 3 STANDBY Indicator**

This indicator is lit when main lead is connected and the power is off.
- 4 POWER Indicator**

This indicator is lit when the power is on.
- 5 REC Indicator**

This indicator is lit when recording is in progress.
- 6 CASSETTE IN Indicator**

This indicator is lit when a cassette is inserted.
- 7 OPEN/CLOSE**

Press to open the front panel or to open/close the cassette tray.
- 8 EDIT**

By connecting a movie camera or VCR with an EDIT socket to this socket via an Edit cable, various kinds of editing functions can be performed more quickly and efficiently between two VCRs or between a VCR and a movie camera.
- 9 DV IN/OUT ()**

To connect the DV cable to digital video equipment with IEEE 1394-1995 compatible DV terminal. "i LINK" is the name of the connector in accordance with the International Standard IEEE1394-1995. "i" is the logo marked on products conforming with the "i LINK" specifications. For further details on the DV terminal, refer to the Glossary of Terms on page 66.
- 10 EDIT MODE**

PLAYER	When this VCR is used as the playback VCR during editing operations
RECORDER	When this VCR is used as the recording VCR during editing operations <ul style="list-style-type: none"> ● Normally set at this position
PASSIVE	When operating this VCR using another VCR or an editing controller <ul style="list-style-type: none"> ● The picture quality best suited for editing is selected
- 11 EDIT CONTROL**

To select a connected component when another component is to be connected for editing, etc.
- 12 DV CASSETTE/MINI CASSETTE Indicators**

This indicator corresponds to the size of the cassette inserted. It is lit.

13 JOG/SHUTTLE Indicator

While this display is lit, the unit is set to the Jog/Shuttle mode

- Check that the display is lit before proceeding with a jog or shuttle operation
- The display is automatically turned off if no operation is performed

14 VIDEO INSERT Indicator

This indicator is lit when the video insert editing is performed

15 AUDIO DUB Indicator

This indicator is lit when the Audio Dubbing or Audio Mixing is performed

16 AUDIO INSERT Indicator

This indicator is lit when the audio insert editing is performed

17 Cassette Tray

18 Indicators for AUDIO MONITOR

The audio track selected by **STEREO SELECT** lights (This applies only to a tape recorded in the 12bit audio mode)

19 MIXING EDIT

For Mixing Editing

20 INPUT SELECT

To select the A1, A2 or DV IN external recording source

21 SP/LP

To select the desired tape speed for recording

22 AUDIO OUT

To select the desired sound mode
When this button is pressed, the audio output mode changes as follows



The Left(L) and Right(R) Indicators shown which sound mode is selected in the following way

- | | |
|--------|------------------------------------|
| Stereo | Both the L and R Indicators appear |
| Left | The L Indicator appears |
| Right | The R Indicator appears |

23 STEREO SELECT

To select the audio track (STEREO1 audio and/or STEREO2 audio) on a tape which was recorded in the 12bit audio mode During playback, each time the button is pressed, the sound changes as follows

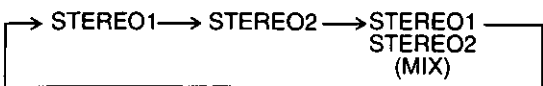

- The audio track cannot be selected during the playback of a tape recorded in the 16bit audio mode
- When **INPUT SELECT** is set to DV IN and a 12bit audio mode input signal is being received, the audio track can be selected by **STEREO SELECT** at any time

24 REC

To start recording

25 AUDIO REC LEVEL

To adjust the audio recording level to peak at +4 dB on the recording level indicator

- When **INPUT SELECT** is set to DV IN the audio recording level cannot be adjusted

26 S-VIDEO IN (AV2)

To connect the S-Video cable to a movie camera or to another VCR that has an S-Video output socket

- If an S-Video cable is connected, other video input (AV2) is automatically switched off

27 VIDEO IN (AV2)

To connect the video cable to a movie camera or to another VCR

28 AUDIO IN (AV2)

To connect the audio cable to a movie camera or to another VCR

29 EDITING CONTROLLER Socket

When using the editing controller separate from the main unit, remove the modular cap and then connect the editing controller cable

30 DV IN/OUT Indicators

DV IN This indicator is lit when **INPUT SELECT** is set to "DV IN"

DV OUT This indicator is lit when a playback operation is performed using this VCR or when **INPUT SELECT** is set to other than "DV IN"

31 Display

32 Indicators for AUDIO DATA

Displays the audio data that is to be recorded, or the audio data on a tape that has already been recorded The audio recording mode can be set in the SET UP MENU

12bit-STEREO1 To play back a tape that is recorded in 12bit audio mode

12bit-STEREO2 To play back a STEREO2 audio tape recorded in the 12bit audio mode

16bit To play back a tape that is recorded in 16bit audio mode

33 AUDIO MIX Level

During the Audio Mixing function
To adjust the volume of the original audio (STEREO1)
During playback of a tape recorded in the 12bit audio mode
To adjust the mix balance between the STEREO1 and STEREO2 audio

35 PHONES

To connect stereo headphones

36 PHONES LEVEL

For adjusting the volume level of connected stereo headphones

34 MIC

To connect to a microphone for recording Once connected, this socket has priority

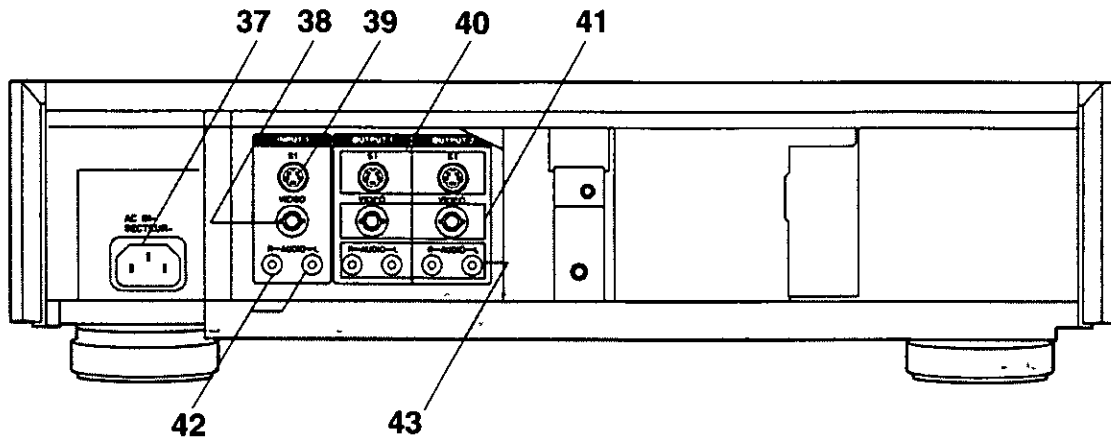

REAR

37 AC IN~

To connect to the main power supply

38 VIDEO IN (INPUT1)

To connect the video cable (BNC) to a movie camera or to another VCR

39 S-VIDEO IN (INPUT1)

To connect the S-Video cable to a movie camera or to another VCR that has an S-Video output socket
• If an S-Video cable is connected, other video input (INPUT1) is automatically switched off

40 S-VIDEO OUT (OUTPUT1/2)

To connect the S-Video cable to a monitor or another VCR that has an S-Video input socket

41 VIDEO OUT (OUTPUT1/2)

To connect the video cable (BNC) to a monitor or to another VCR

42 AUDIO IN (INPUT1)

To connect the audio cable to a movie camera or to another VCR

43 AUDIO OUT (OUTPUT1/2)

To connect the audio cable to a stereo audio system



Infra-red Remote Controller

Before Use

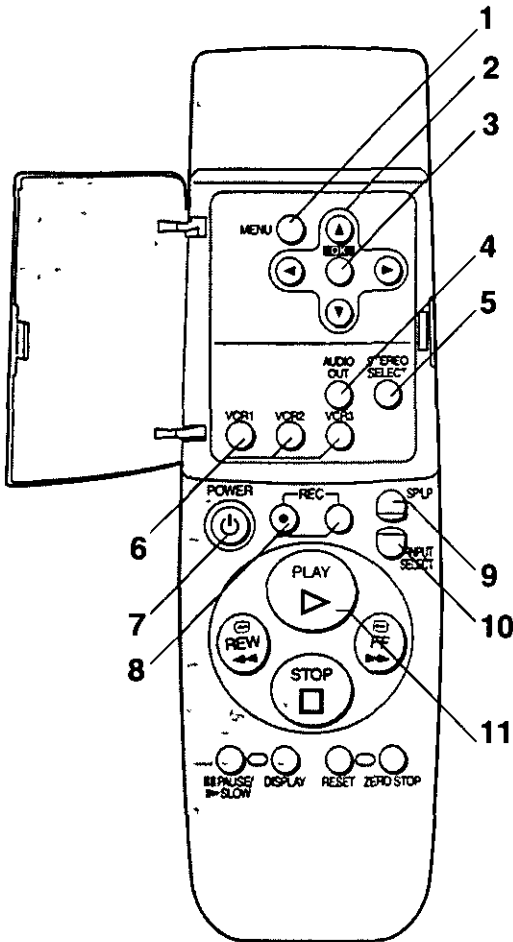

The Left(L) and Right(R) Indicators shown which sound mode is selected in the following way

Stereo	Both the L and R indicators appear
Left	The L Indicator appears
Right	The R Indicator appears

5 STEREO SELECT

To select the audio track (STEREO1 audio and/or STEREO2 audio) on a tape which was recorded in the 12bit audio mode. During playback, each time the button is pressed, the sound changes as follows



- The audio track cannot be selected during the playback of a tape recorded in the 16bit audio mode
- When **INPUT SELECT** is set to DV IN and a 12bit audio mode input signal is being received, the audio track can be selected by **STEREO SELECT** at any time

6 VCR1/2/3

While holding down **POWER** , press one of these buttons to select the remote control mode

- | | |
|------|---|
| VCR1 | Set this position on both the VCR and remote controller for normal use with one VCR |
| VCR2 | Set this position when using two Panasonic VCRs |
| VCR3 | Set this position when using three Panasonic VCRs |

- When the VCR's remote control mode has been switched, select the same remote control mode on the editing controller as well

1 MENU

To make the On Screen Display Main menu appear on the monitor screen

2 ▲ ▼ ◀ ▶

To make selections from the On Screen Display

3 OK

To confirm the selection, or to store

4 AUDIO OUT

To select the desired sound mode
When this button is pressed, the audio output mode changes as follows

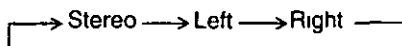

7 POWER

Press to switch the unit from on to standby mode or vice versa. In standby mode, the unit is still connected to the mains

8 REC

To start recording
Press both buttons at the same time

9 SP/LP

To select the desired tape speed for recording

10 INPUT SELECT

To select the A1, A2 or DV IN external recording source

11 ▷ (PLAY)

To start playback "▷" is lit during playback

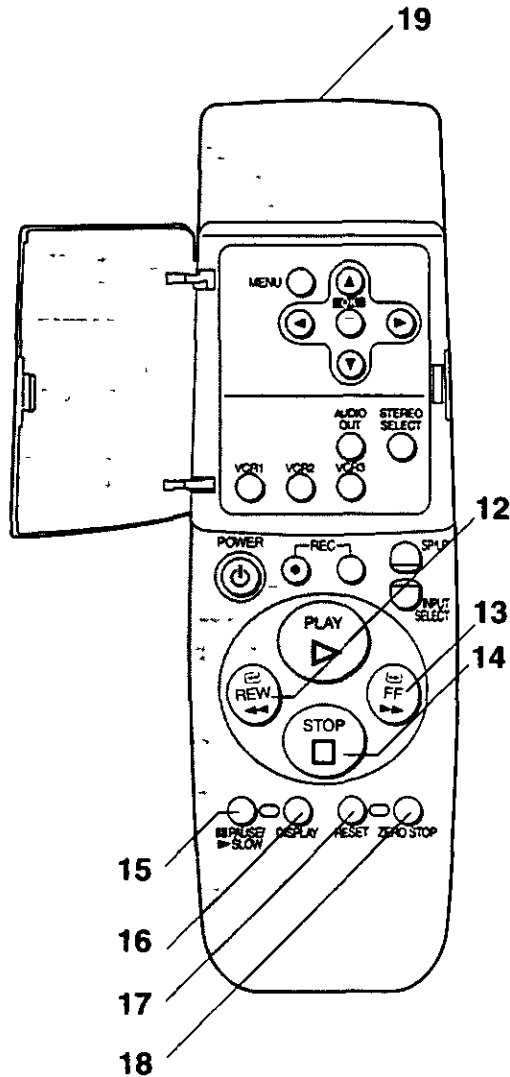

12 ◀◀ (REW)

- In the stop mode To rewind the tape
 - In the playback mode To search backward for a scene
 - In the rewind mode To view the video
- "◀◀" is lit during rewind

13 ▶▶ (FF)

- In the stop mode To fast forward the tape
 - In the playback mode To search forward for a scene
 - In the fast forward mode To view the video
- "▶▶" is lit during fast forward

14 ◻ (STOP)

To stop playback or recording

15 PAUSE/SLOW (||▶)

- During playback
 - When pressed once Still picture "◻◻" is lit
 - When pressed for 2 seconds or more Slow playback "||▶" is lit
- During recording To pause recording

16 DISPLAY

To change the VCR display indication as follows

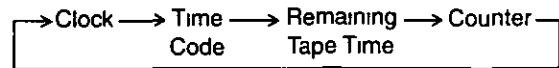

- The time code frame values are not displayed on the main unit's VCR display

17 RESET

- To reset the tape counter (elapsed time) to "0 00 00"
- The tape counter is automatically reset to "0 00 00" when a video cassette is inserted
- It is not possible to reset the Time code to "0h00m00s00f" using **RESET**

18 ZERO STOP

For the zero stop function

19 Infra-red Transmitter



Editing Controller

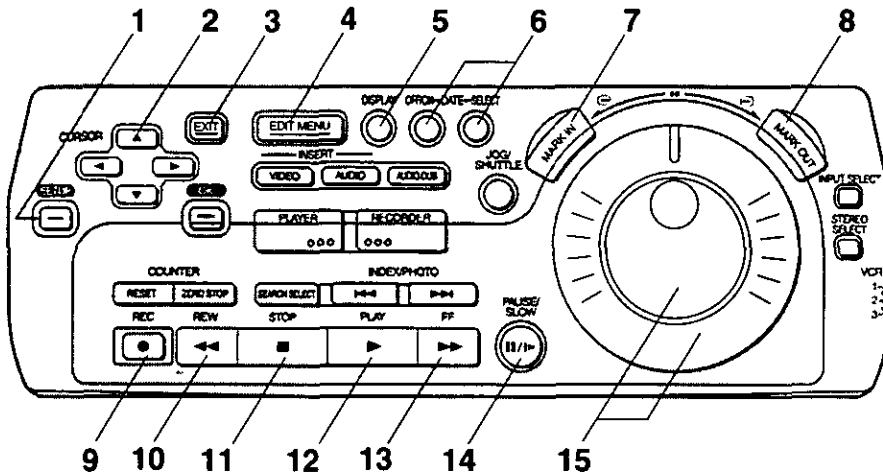

1 SET UP

To make the SET UP screen appear on the monitor screen. When the SET UP screen is displayed, use this button to return to the previous screen.

2 ▲ ▼ ◀ ▶ (CURSOR)

To make selections from the SET UP or EDIT MENU screen. (When the SET UP or EDIT MENU screen is displayed.)

3 EXIT

To exit the SET UP or EDIT MENU screen.

4 EDIT MENU

To make the EDIT MENU screen appear on the monitor screen, and to return to the previous screen. This button is also used to stop editing functions using the EDIT MENU screen.

5 DISPLAY

To change the VCR display indication as follows:

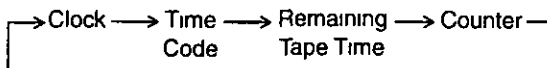

• The time code frame values are not displayed on the main unit's VCR display.

6 DATE-OFF/ON, DATE-SELECT

When pictures are recorded using this VCR or a Panasonic Digital Video Camera, the date and time of the recording are automatically recorded onto the tape's sub code track.

This button is used to select the information to be displayed on the On Screen Display.

DATE-OFF/ON:

To make the Date/Time indication appear on the monitor screen.

DATE-SELECT:

To change the indication to be displayed on the monitor screen as follows:

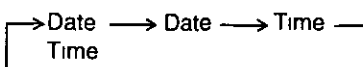

7 MARK IN

To set edit start points for Program Editing.

8 MARK OUT

To set edit end points for Program Editing.

9 REC

To start recording.

10 ◀◀ (REW)

In the stop mode	To rewind the tape
In the playback mode	To search backward for a scene
In the rewind mode	To view the video

"◀◀" is lit during rewind.

11 ■ (STOP)

To stop playback or recording.

12 ▶ (PLAY)

To start playback. "▶" is lit during playback.

13 ▶▶ (FF)

In the stop mode	To fast forward the tape
In the playback mode	To search forward for a scene
In the fast forward mode	To view the video

"▶▶" is lit during fast forward.

14 PAUSE/SLOW (||/▶)

During playback:

- When pressed once: Still picture "□□" is lit.
- When pressed for 2 seconds or more: Slow playback "||▶" is lit.

During recording:

To pause recording.

15 Jog Dial/Shuttle Ring

Jog Dial (inner dial)

Operate after pressing JOG/SHUTTLE to switch to the Jog/shuttle mode.

To locate any desired field with utmost precision.

Shuttle Ring (outer ring)

Operate after pressing JOG/SHUTTLE to switch to the Jog/shuttle mode.

To adjust playback speed backward or forward.

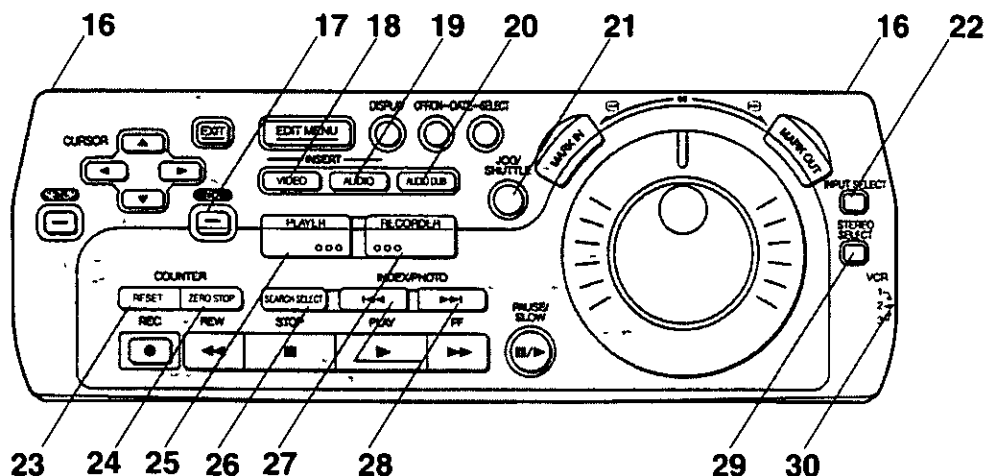

16 Infra-red Transmitter

17 OK

To start Manual editing and to store the selection on the SET UP or EDIT MENU screen

18 VIDEO INSERT

For the Video Insert function and the AV Insert function

19 AUDIO INSERT

For the Audio Insert function and the AV Insert function

20 AUDIO DUB

For the Audio Dubbing function or the Audio Mixing function

21 JOG/SHUTTLE

To switch to the Jog/Shuttle mode. When the button is pressed, it lights and the VCR enters the Jog/Shuttle mode.

In the stop mode Still picture (Jog/Shuttle mode)

During playback Still picture (Jog/Shuttle mode)

22 INPUT SELECT

To select the A1, A2 or DV IN external recording source

23 RESET

To reset the tape counter (elapsed time) to "0 00 00"

- The tape counter is automatically reset to "0 00 00" when a video cassette is inserted
- It is not possible to reset the Time code to "0h00m00s00f" using RESET.

24 ZERO STOP

For the zero stop function

25 PLAYER

To operate the playback unit

26 SEARCH SELECT

To search for a recorded program using the index/ photoshot index search

27 RECORDER

To operate the recording VCR

28 INDEX/PHOTO

For the index/photoshot index search function

29 STEREO SELECT

To select the audio track (STEREO1 audio and/or STEREO2 audio) on a tape which was recorded in the 12bit audio mode. During playback, each time the button is pressed the sound changes as follows:



- The audio track cannot be selected during the playback of a tape recorded in the 16bit audio mode
- When INPUT SELECT is set to DV IN, the audio track can be selected by STEREO SELECT at any time. It does not have to be during playback.

30 VCR1/2/3

To select the remote control mode. The selected mode appears on the remote controller display.

- VCR1 Set this position on both the VCR and remote controller for normal use with one VCR
- VCR2 Set this position when using two Panasonic VCRs
- VCR3 Set this position when using three Panasonic VCRs

Note

While in the editing mode the VCR's Time code or tape counter display cannot be changed

Remote Controller Setup

Installing the Batteries

- 1 To remove the cover, slide it in the direction of the arrow while pressing down

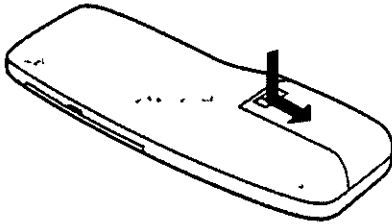

- 2 Load the batteries with their polarity (\oplus and \ominus) aligned correctly

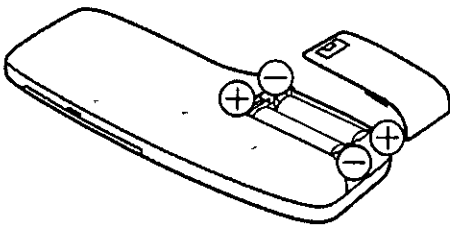

- 3 Slide the cover back on

Power Source for the Remote Controller

The remote controller is powered by 2 AA, UM3 or R6 size batteries. The life of the batteries is about one year, although this depends on the frequency of use.

Precautions for Battery Replacement

- Load the new batteries with their polarity (\oplus and \ominus) aligned correctly
- Do not apply heat to the batteries, or an internal short-circuit may occur
- If you do not intend to use the remote controller for a long period of time, remove the batteries and store them in a cool, dry place
- Remove spent batteries immediately and dispose of them
- Do not use an old and a new battery together, and never use an alkaline battery with a manganese battery
- Do not use rechargeable batteries

Editing Controller Set Up

Installing the Batteries

- 1 To remove the cover, slide it in the direction of the arrow while pressing down

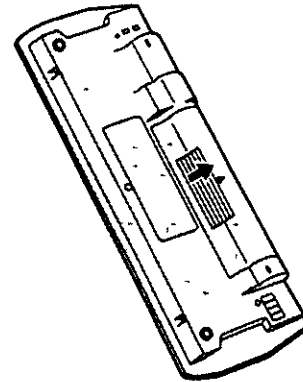

- 2 Load the batteries with their polarity (\oplus and \ominus) aligned correctly

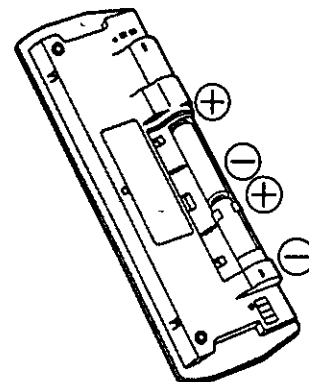

- 3 Slide the cover back on

Power Source for the Editing Controller

The editing controller is powered by 2 AA, UM3 or R6 size batteries. The life of the batteries is about one year, although this depends on the frequency of use.

Precautions for Battery Replacement

- Load the new batteries with their polarity (\oplus and \ominus) aligned correctly
- Do not apply heat to the batteries, or an internal short-circuit may occur
- If you do not intend to use the editing controller for a long period of time, remove the batteries and store them in a cool, dry place
- Remove spent batteries immediately and dispose of them
- Do not use an old and a new battery together, and never use an alkaline battery with a manganese battery
- Do not use rechargeable batteries

Operating the Editing Controller

The Editing controller can be operated in any of the following 3 ways

- It can be operated while remaining attached to the main unit
- Its batteries can be loaded, and it can be separated from the main unit and operated as the remote controller
- It can be separated from the main unit, connected using the accessory editing controller cable and operated as the remote controller

How to separate the editing controller

While pressing the buttons at the left and right of the main unit's front panel, remove the editing controller with both hands

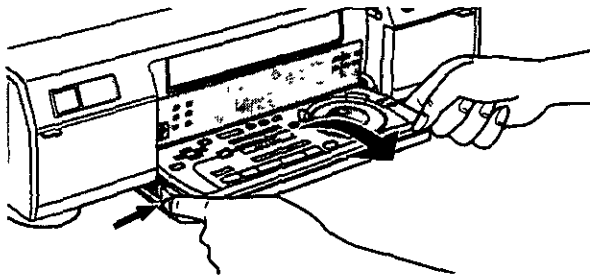

How to attach the editing controller

Push down on the editing controller until the areas around the left and right buttons on the unit's front panel click into position

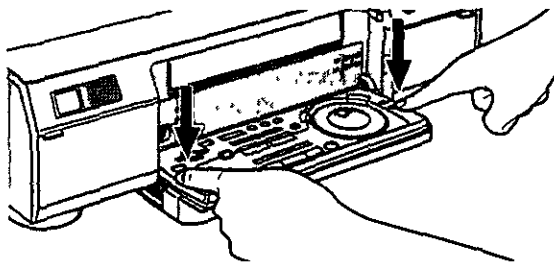

When connecting the editing controller to the video unit using the editing controller cable

- 1 Remove the cover over the controller socket on the rear panel of the editing controller, and insert the plug at one end of the editing controller cable into this socket until it clicks into position



- 2 Remove the modular cap over the unit's controller socket, and insert the plug at the other end of the editing controller cable into this socket until it clicks into position

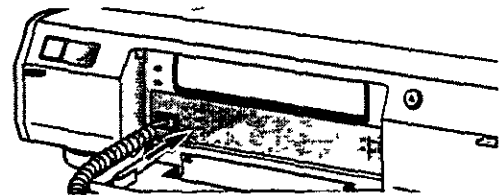

When using the editing controller as a remote controller

As a remote controller, the editing controller can be operated at a distance up to about 3 m in front and up to an angle of up to about 30 degrees to the left or right of centre (This range changes in accordance with the ambient brightness)

Note

When the VCR's remote control mode has been switched, switch the remote control mode on the editing controller as well

Connections

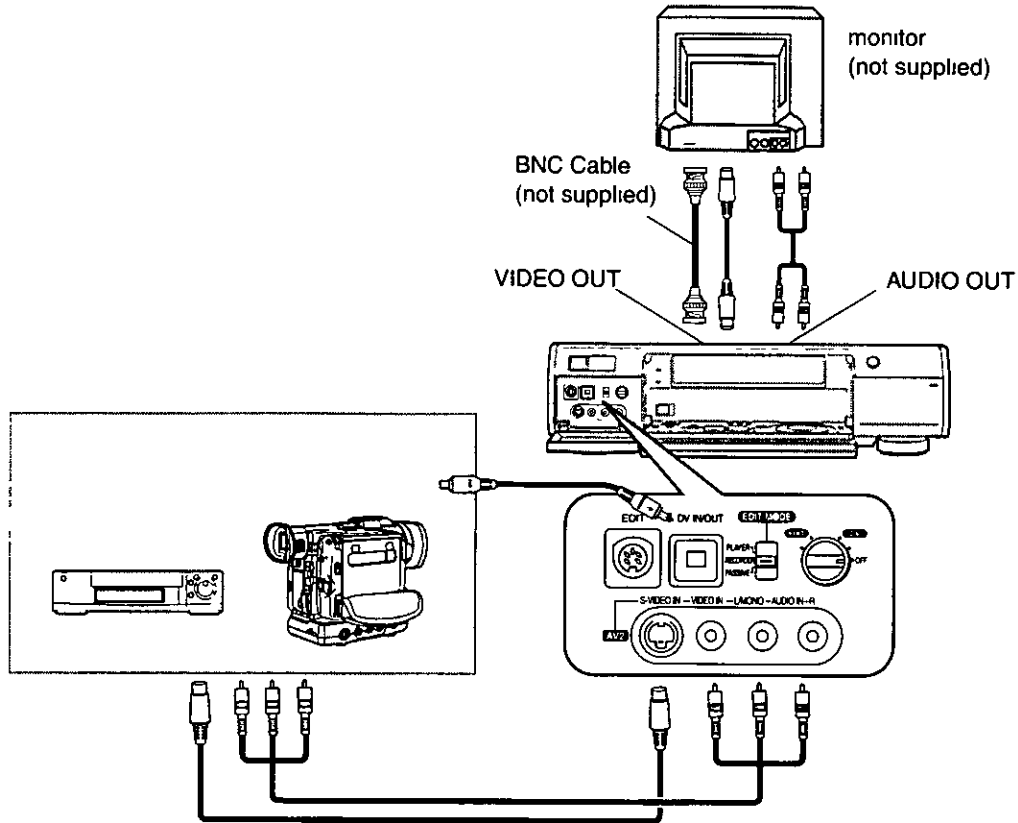

- Use AV cables to connect the input sockets on this unit with the output sockets on the video equipment
- Press **INPUT SELECT** on this unit so that A1, A2 or DV IN is selected
- When using the BNC socket, use a BNC-PHONO conversion adapter (sold separately)
- If the video equipment is connected to this unit via an S-VIDEO cable, the video signal on the S-VIDEO cable takes priority
If the video equipment does not have an S-VIDEO socket do not connect the S-VIDEO cable to this unit

Inserting the Cassette

- 1 Press **OPEN/CLOSE**
 - The front panel opens

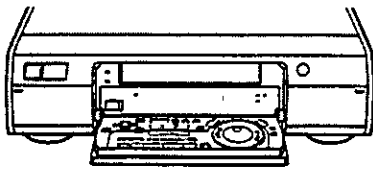

- 2 Press **OPEN/CLOSE** again
 - The cassette tray is extended

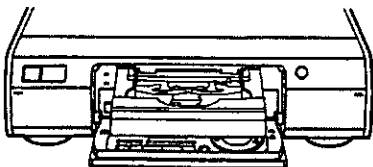

- 3 Align the cassette with the cassette guide and place it on the tray while ensuring that the side of the cassette with the tape exposed is facing up and the label side is turned toward you

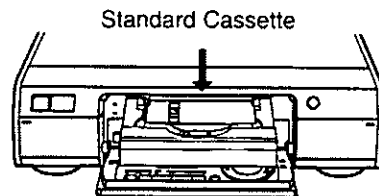
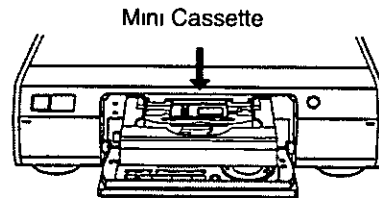





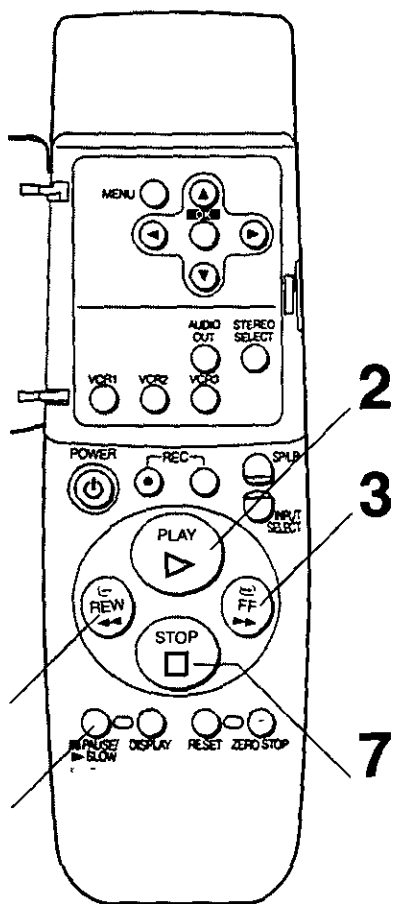
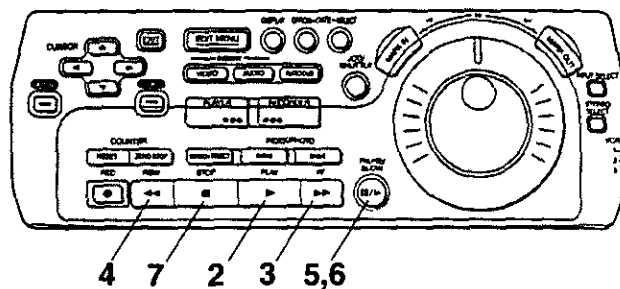
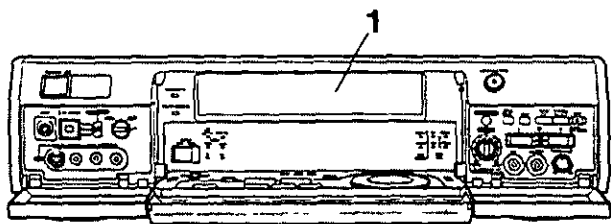

- 4 Press **OPEN/CLOSE**
 - The cassette tray is retracted inside the video unit

Playback



Operations

Display Symbols

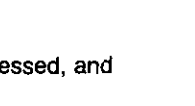
- | | | |
|----------|---|---|
| 1 | Insert a recorded cassette tape (page 13) |  |
| 2 | Press ▷ (PLAY) to start playback |  |
| 3 | Tap ▶▶ (FF) to search forward
• Press ▷ (PLAY) to change back to normal playback |  |
| 4 | Tap ◀◀ (REW) to search backward
• Press ▷ (PLAY) to change back to normal playback |  |
| 5 | Press PAUSE/SLOW to view a still picture.
• Press ▷ (PLAY) or PAUSE/SLOW to continue normal playback |  |
| 6 | Keep PAUSE/SLOW pressed for 2 seconds or more to view a slow motion picture
• Press ▷ (PLAY) to continue normal playback |  |
| 7 | Press ◻ (STOP) to stop the picture |  |

Note

If you keep **▶▶ (FF)** or **◀◀ (REW)** pressed in step 3 or 4, search playback is activated while the button is pressed, and operation returns to normal playback when the button is released

Manual Recording

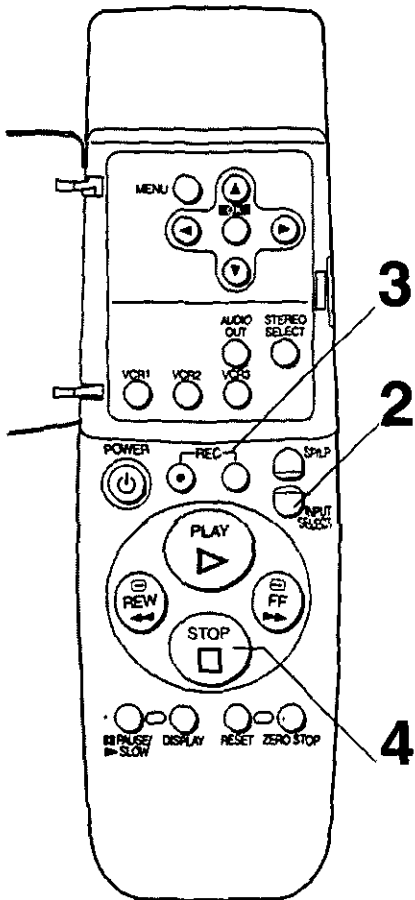
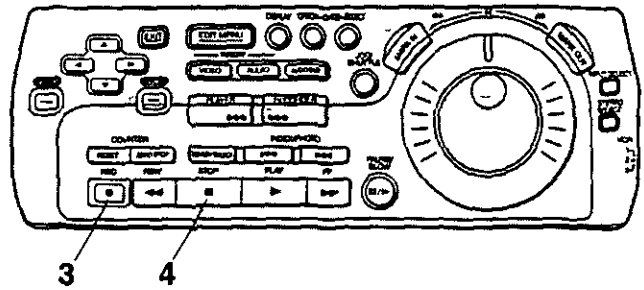
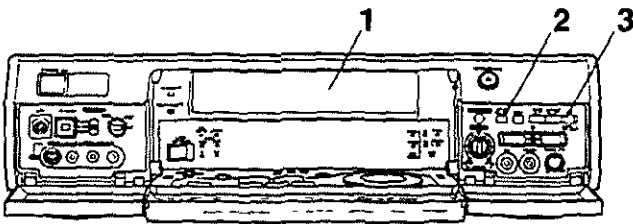

Operations

Display Symbols

- 1** Insert a video cassette with the closed record prevention tab (page 13)
- If it has already been inserted, press **POWER** (POWER \odot/I) to turn the VCR on



- 2** Press **INPUT SELECT** on this unit so that A1, A2 or DV IN



- 3** Press **REC** to start recording.



- 4** Press **STOP** to stop recording.

To Select the Desired Tape Speed
Press **SP/LP** before recording



To Pause Recording
Press **PAUSE/SLOW** during recording
Press again to continue recording



To Select the Desired Audio Mode
Perform the procedure below using the editing controller

- 1 Press **SET UP**
- 2 Using $\blacktriangle/\blacktriangledown$, select **Audio Mode** and press **OK**
- 3 Using $\blacktriangleleft/\blacktriangleright$, select **12bit** or **16bit**, then press **OK**

For details, see Initial Settings for Editing on page 30

Note

A long-Mini DV cassette (SP/80 min , LP/120 min) that was recorded by this VCR cannot be played back or recorded by a DVCPRO or DVCPRO 50 format VCR

Search Functions

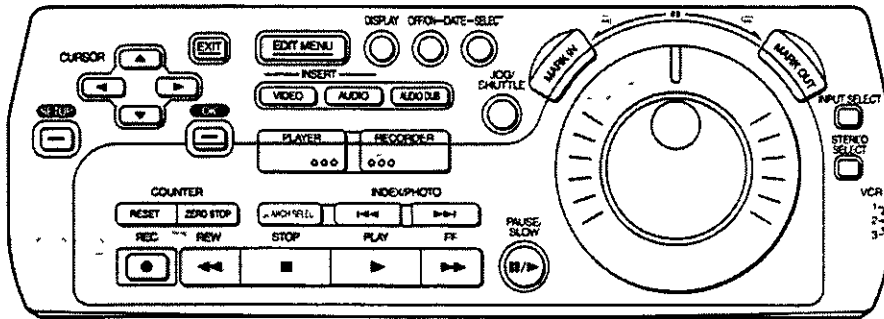

Index Search System

It is easy to find the beginning of each recording because a special index signal is recorded at the start of each recorded segment on the tape

For example:

Searching for the 2nd recorded segment in the forward direction

- 1 Press **SEARCH SELECT** so that "S --" appears on the VCR display
(This operation is performed while the VCR is in the stop mode or normal playback mode)



- 2 Press **INDEX/PHOTO** **▶▶▶** twice
 - After finding the specific recorded segment, playback starts automatically

Display Symbols



To stop the operation at any time

Press **■ (STOP)**

- For the reverse direction, press **INDEX/PHOTO** **◀◀◀**
- Up to 20 index signals can be searched for in either direction
- When the opposite **INDEX/PHOTO** is pressed, the number shall be decreased until 1 is reached
- The figure on the display is reduced by 1 each time an index signal is located
- The INDEX search function can only work correctly if the index signals are spaced at least 5 minutes apart
- Repeat the procedure if the index signal for the specified number is not found

Recording Index Signals

Index signals are recorded in the following cases

- When a recording is started by pressing **REC**
- When **REC** on the remote controller or the editing controller is pressed during recording

Photoshot Index Search System

Photo shot index signals are automatically recorded when a Panasonic Digital Video Camera is used for Photo shot Mode. Photo shot images are searched using these signals, and when such an image is located, the image is played back as a still picture

For example

Searching for the 2nd photo shot image in the forward direction

- 1 Press **SEARCH SELECT** so that "PHOTO S --" appears on the VCR display



- 2 Press **INDEX/PHOTO** **▶▶▶** twice
 - After finding the specific image, playback starts automatically

Display Symbols



To stop the operation at any time

Press **■ (STOP)**

- For the reverse direction, press **INDEX/PHOTO** **◀◀◀**
- Any of up to 20 images ahead on the tape can be designated
- When the opposite **INDEX/PHOTO** is pressed, the number shall be decreased until 1 is reached
- It may not be possible to search for a particular image properly if photo shot images have been recorded continuously
- At every press of the corresponding button, the tape is fast-forwarded or rewound to the next still picture recorded in the Photoshot Mode
After reaching the next still picture, the still picture is played back continually together with the sound (only for approx 4 seconds)

Setting the Clock of Your VCR

The built-in digital clock employs the 24-hour system

Preparations

- Confirm that the monitor is on and the VCR viewing channel is selected
- Turn on the VCR and monitor

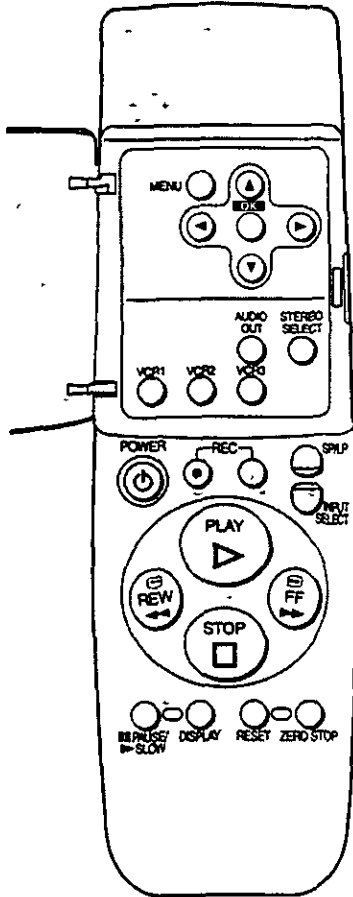

Operations

- 1 Press **MENU**, and then select **CLOCK ADJUST**

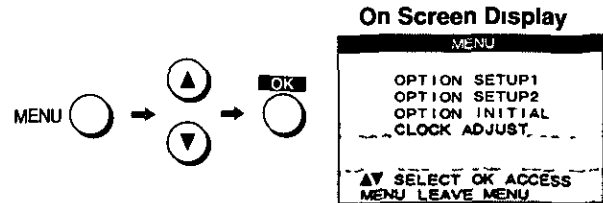

- 2 Set **Time and Date**.
 - Press **←** to return to the previous item

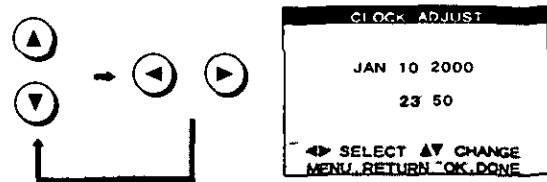

- 3 Press **OK** to confirm.

- 4 Press **MENU** to exit the On Screen Display

Settings Using On Screen Display

The VCR indications shown on the monitor screen are known as the On Screen Display (OSD)
This VCR allows many settings to be made at the OSD

Preparations

- Confirm that the monitor is on and the VCR viewing channel is selected
- Turn on the VCR and monitor

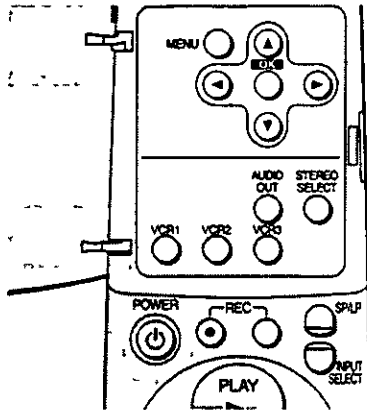

To use the On Screen Display

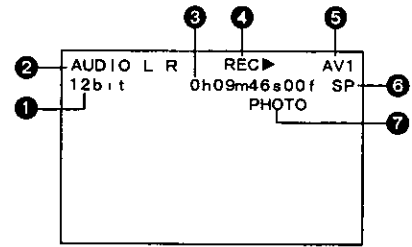

1 Audio Data Indicator

2 Audio Output Mode Indicator

The Left (L) and Right (R) Indicators show which sound mode is selected with **AUDIO OUT** (see page 5 or 7)

- Stereo Both the AUDIO L and R Indicators appear
- Left The AUDIO L Indicator appears
- Right The AUDIO R Indicator appears

3 Present time/Time code/Remaining tape time/ Tape counter/Index/Photoshot Index Search

Present date and time	JUN 11 19 22
Time code	0h09m46s00f
Remaining tape time	REMAIN 1 16
Tape counter	- 1 35 47
Index/Photoshot index Search	S 02

4 Tape running display

Stop	
Playback/Reverse Playback	PLAY▶/PLAY◀
Still Playback	STILL■
Fast Forward/Rewind	FF▶▶/REW◀◀
Cue/Review	CUE▶▶/REV◀◀
Slow/Reverse Slow Playback	SLOW
Recording/Recording Pause	REC▶/REC■
Video Insert/Insert Pause	VID INS▶/VID INS■
Audio Insert/Insert Pause	AUD INS▶/AUD INS■
AV Insert/Insert Pause	AV INS▶/AV INS■
Audio Dubbing/Dubbing Pause	A DUB▶/A DUB■

5 External Input Indicator

6 Tape speed Indicator

7 Index/Photoshot Index Search Indicator

OSD Mode

- 1 Press **MENU**, and then select **OPTION SETUP1**

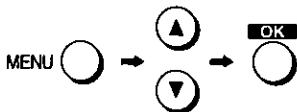

On Screen Display

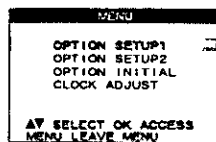

- 2 Select **OSD MODE**

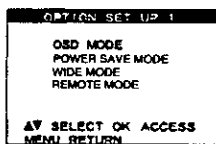
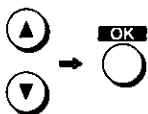

- 3 Select **AUTO, ON or OFF**

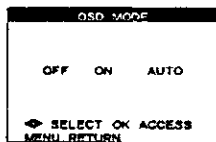
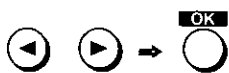

- AUTO** The On Screen Display will appear on the monitor screen for a few seconds when you operate the VCR
- ON** The On Screen Display will always appear on the monitor screen when you perform the VCR
- OFF** The On Screen Display will not appear

- 4 Press **MENU** twice to exit the On Screen Display

Notes

- When the item "OSD MODE" is set to **OFF**, the On Screen Display will not appear
- When "COLOR MODE" is set to **OFF**, the On Screen Display will not appear
- On Screen Display is not displayed when the SET UP or EDIT MENU screen is displayed

Power Save Mode

- 1 Press **MENU**, and then select **OPTION SETUP1**

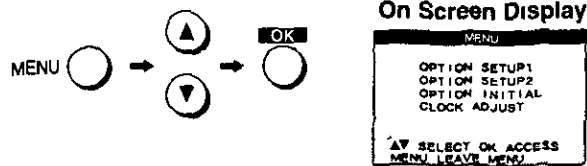

- 2 Select **POWER SAVE MODE**



- 3 Select **OFF, 2H or 6H.**



- OFF** This setting does not conserve power when the VCR is off
- 2H** The VCR turns off automatically if no operation is performed for approximately two hours
- 6H** The VCR turns off automatically if no operation is performed for approximately six hours

- 4 Press **MENU** twice to exit the On Screen Display

Wide Mode

- 1 Press **MENU**, and then select **OPTION SETUP1**



- 2 Select **WIDE MODE.**



- 3 Select **OFF or S1.**



- OFF** When the S-Video input socket on the monitor that is connected is an S-Video socket
- S1** When the S-Video input socket on the monitor that is connected is an S1-Video socket (If a wide mode video signal is sent to the monitor, the monitor screen size will automatically switch to wide mode)

- 4 Press **MENU** twice to exit the On Screen Display

To Set the Remote mode

- 1 Press **MENU**, and then select **OPTION SETUP1**

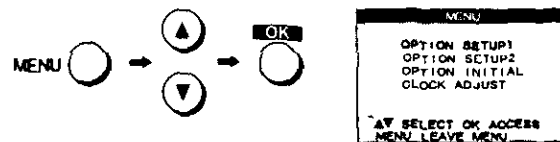

- 2 Select **REMOTE MODE**



- 3 Select **VCR1, VCR2 or VCR3**



This allows the remote controller to be set for operating VCR1, VCR2 or VCR3

- When changing the remote control mode, press **VCR1, VCR2 or VCR3** while holding down **POWER** to change the remote control mode of the remote controller. If this is not done, it will not be possible to operate the VCR using the remote controller

- 4 Press **MENU** twice to exit the On Screen Display

3D Y/C Mode

1 Press **MENU**, and then select **OPTION SETUP2**

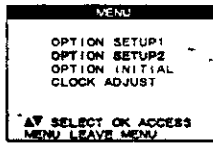
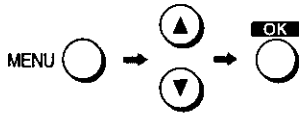

2 Select **3D Y/C MODE**.

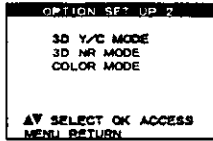
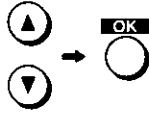

3 Select **OFF** or **ON**

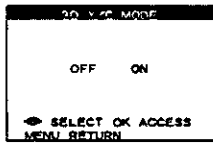

- OFF To reduce ghosting that occurs when playing back or recording a fast-moving video
- ON To record with high quality

4 Press **MENU** twice to exit the On Screen Display

3D NR Mode

1 Press **MENU**, and then select **OPTION SETUP2**.

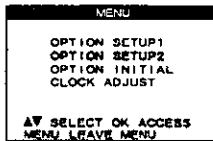
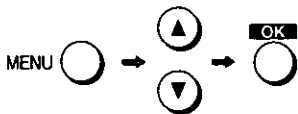

2 Select **3D NR MODE**

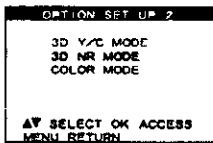
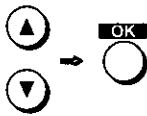

3 Select **OFF, LEVEL1** or **LEVEL2**.

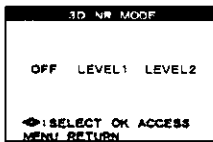

- OFF To use this VCR as the playback unit during editing
- LEVEL1 To get better picture quality during playback
- LEVEL2 When there is a lot of picture noise on the screen

4 Press **MENU** twice to exit the On Screen Display

To Set the Color Mode

1 Press **MENU**, and then select **OPTION SETUP2**

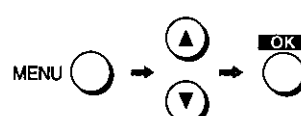

2 Select **COLOR MODE**

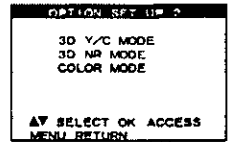
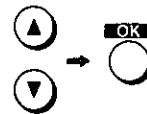

3 Select **OFF** or **ON**.

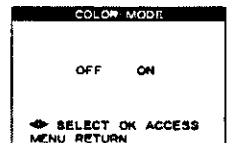

- OFF When performing recording and playback in black-and-white
- ON When performing recording and playback in color

4 Press **MENU** twice to exit the On Screen Display

Initial Setting

If you want to return the VCR to the factory-preset condition, follow the procedure below

1 Press **MENU**, and then select **OPTION INITIAL**

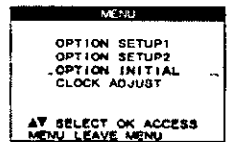
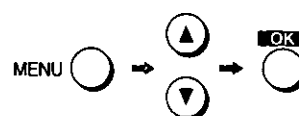

•The message "INITIAL COMPLETED " appears at the bottom of the screen

2 Press **MENU** to exit the On Screen Display

Editing Functions

Using this VCR, 4 types of **One-Touch-Edit**, 3 types of **Manual Editing** and 3 types of **Program Editing** can be selected

In Program Editing, after setting the edit start/end point, editing can be performed automatically. Edit programs can be set up to 10 scenes for each editing function (40 scenes for Assemble editing)

One-Touch-Edit

- Assemble Editing (page 36)
- Insert Editing (Video, Audio, AV) (page 38)
- Audio Dubbing (page 38)
- Audio Mixing (page 40)

Manual Editing

- Copying (page 42)
- Insert Editing (Video, Audio, AV) (page 44)
- Audio Dubbing (page 46)

Program Editing

- Assemble Editing (page 48)
- Insert Editing (Video, Audio, AV) (page 52)
- Audio Dubbing (page 56)

Copying

Allows the re-recording (copying) of the picture and sound from one tape onto another tape

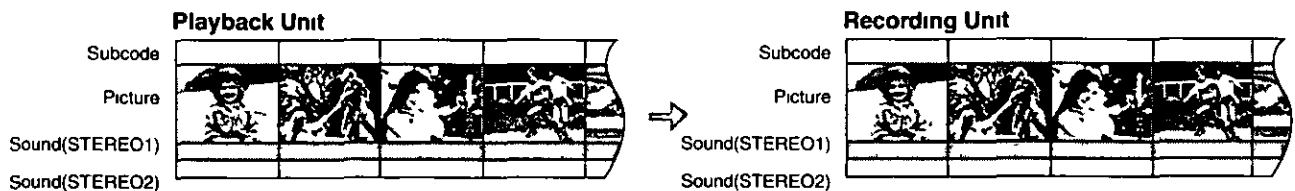

Performing the Copying operation on a tape that was recorded in 12bit audio mode

Video Insert

Allows the partial replacement of the picture on a recorded tape. Sound is left in its original state

Audio Insert

Allows the partial replacement of sound on a recorded tape. Picture is left in its original state

AV Insert

Allows the partial replacement of the picture and sound on a recorded tape

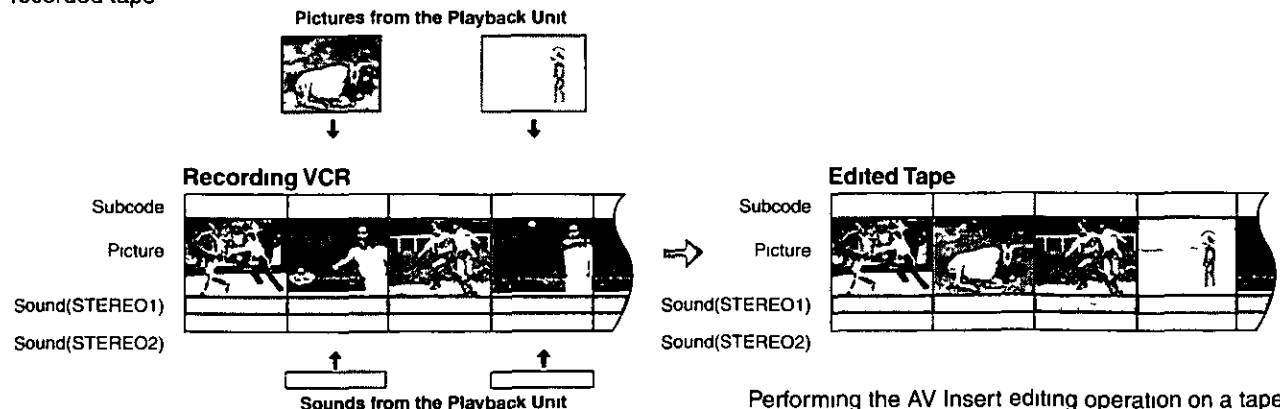

Performing the AV Insert editing operation on a tape that was recorded in 12bit audio mode

Audio Dubbing

Allows the addition of the new sound on the STEREO2 track of a recorded tape. The original sound is left on the STEREO1 track.

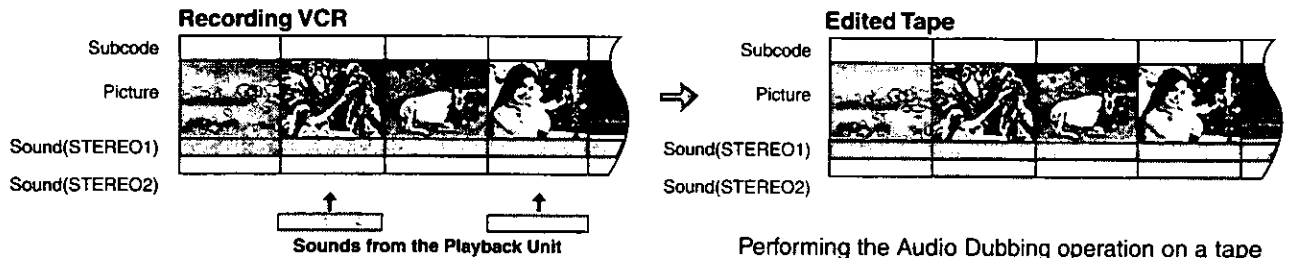

Performing the Audio Dubbing operation on a tape that was recorded in 12bit audio mode.

Audio Mixing

Allows the mixing of the the original sound on the STEREO1 track with the new sound from the external recording source and recording the mixed sound on the STEREO2 track of a recorded tape. The original sound is left on the STEREO1 track.

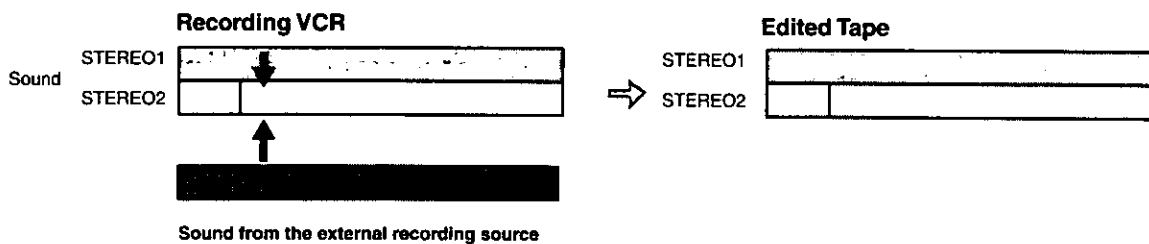

Assemble Editing

Allows the required scenes (picture and sound) to be picked up from a recorded tape and recorded in any desired order onto another tape.

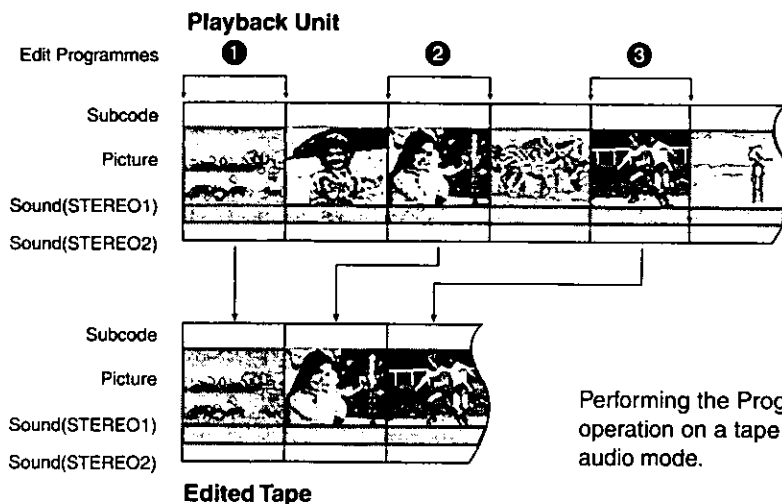

Performing the Program Assemble editing operation on a tape that was recorded in 12bit audio mode.



Connecting with a Digital Video Camera

Example for connecting Panasonic Digital Video Camera as the playback unit, when controlling the playback unit through this unit

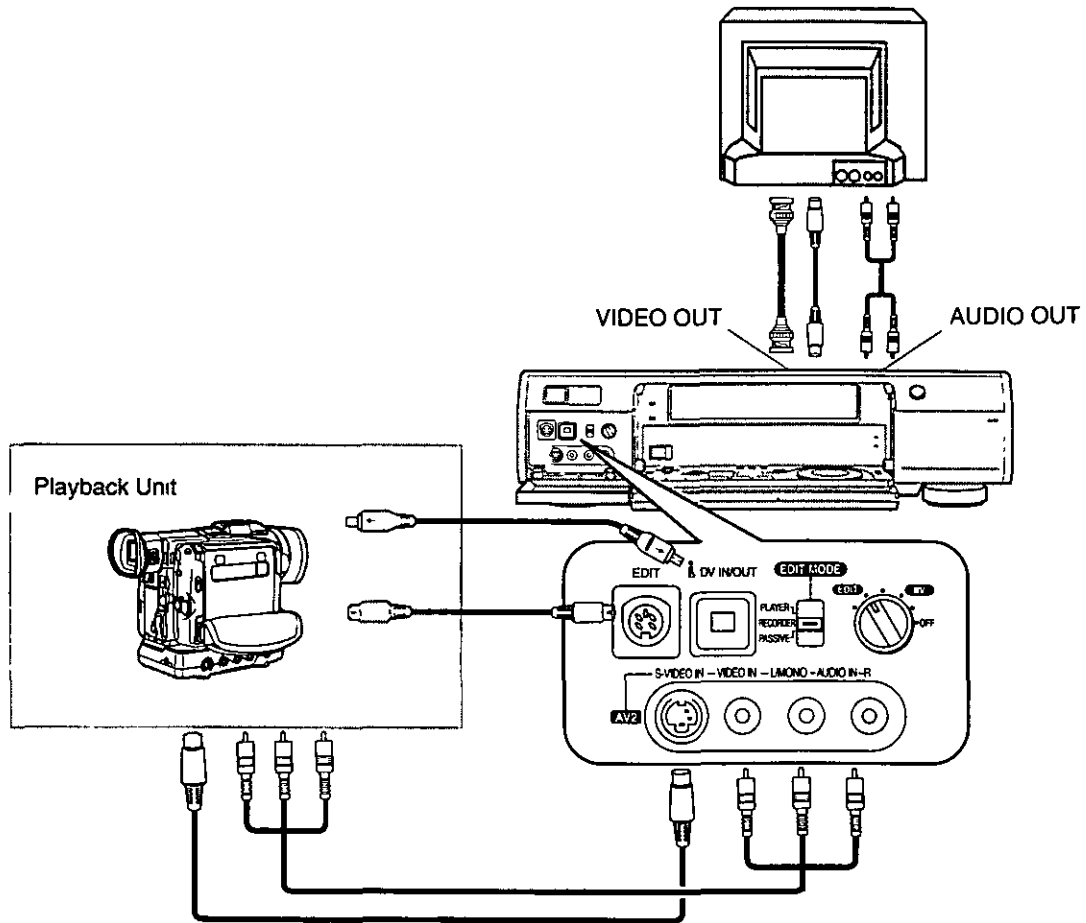

Notes:

- Before connecting any cables, first make sure that the power for both units is off
- Insert a recorded cassette into the playback unit, and a cassette with the closed record prevention tab into the VCR
- If the playback unit is connected to the recording unit via an S-VIDEO cable, the video signal on the S-VIDEO cable takes priority. If the playback unit does not have an S-VIDEO socket do not connect the S-VIDEO cable to this unit
- Use of an AC adaptor as the power source for the Digital Video Camera is recommended. Doing so avoids a situation where the camera shuts down due to low battery power
- It is recommended that the DV cable be disconnected for editing with **INPUT SELECT** set to A1 and A2. If **INPUT SELECT** is set to A1 and A2 with the connections shown in the figure left unchanged, the monitor picture may be disturbed or noise may occur. (This has no effect on the actual editing operations.)
- When the units are connected using the DV cable and editing is performed, some editing functions will differ compared with when the units are connected using the AV cable. Refer to Glossary of Terms on page 66
- Read the operating instructions of the Digital Video Camera
- Do not change the **EDIT CONTROL** or **EDIT MODE** settings while performing setting or editing operations at the SET UP or EDIT MENU screens. Be sure to quit these screens before changing these settings
- When using a Panasonic Digital Video Camera as the playback unit, the following editing functions can be used by connecting the camera to this unit with a DV cable:
 - Copying
 - Video Insert
 - Audio Insert
 - Assemble
 In this case, simply set **INPUT SELECT** to DV IN, and set **EDIT CONTROL** to DV. (This function may not operate properly with some models.)
- Use Time codes for Program Editing when the playback unit is connected to this unit via a DV cable
- When using the BNC socket, use a BNC-PHONO conversion adapter (sold separately)

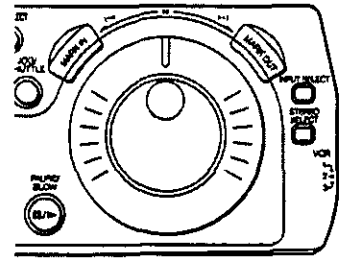
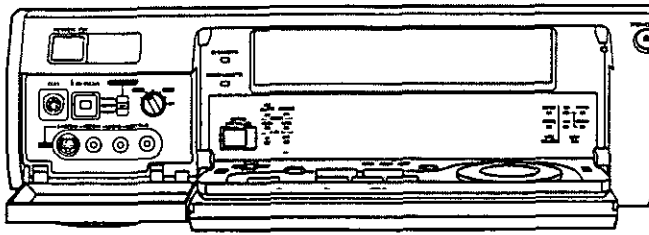

Playback Unit (Digital Video Camera)

-
- 1** Turn the power on.
-
- 2** Make the Time code appear on the LCD monitor or the viewfinder
-
- 3** Prepare the tape for playback.
-

Recording Unit (this unit)

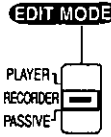
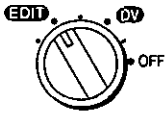
-
 - 1** Turn the power on.
 -
 - 2** Set **EDIT MODE** to **RECORDER**.
- 
-
 - 3** Set **EDIT CONTROL** to **EDIT**.
- 
-
 - 4** Press **INPUT SELECT** so that DV IN is selected
 - When performing Audio Dubbing or AV Insert, select A1 or A2
 -



Connecting Two Digital Video Cassette Recorders (Using two AG-DV2000)

Example for connecting this unit, when controlling the playback VCR through the recording VCR

Refer to the diagram below and connect the cables required for the desired editing function

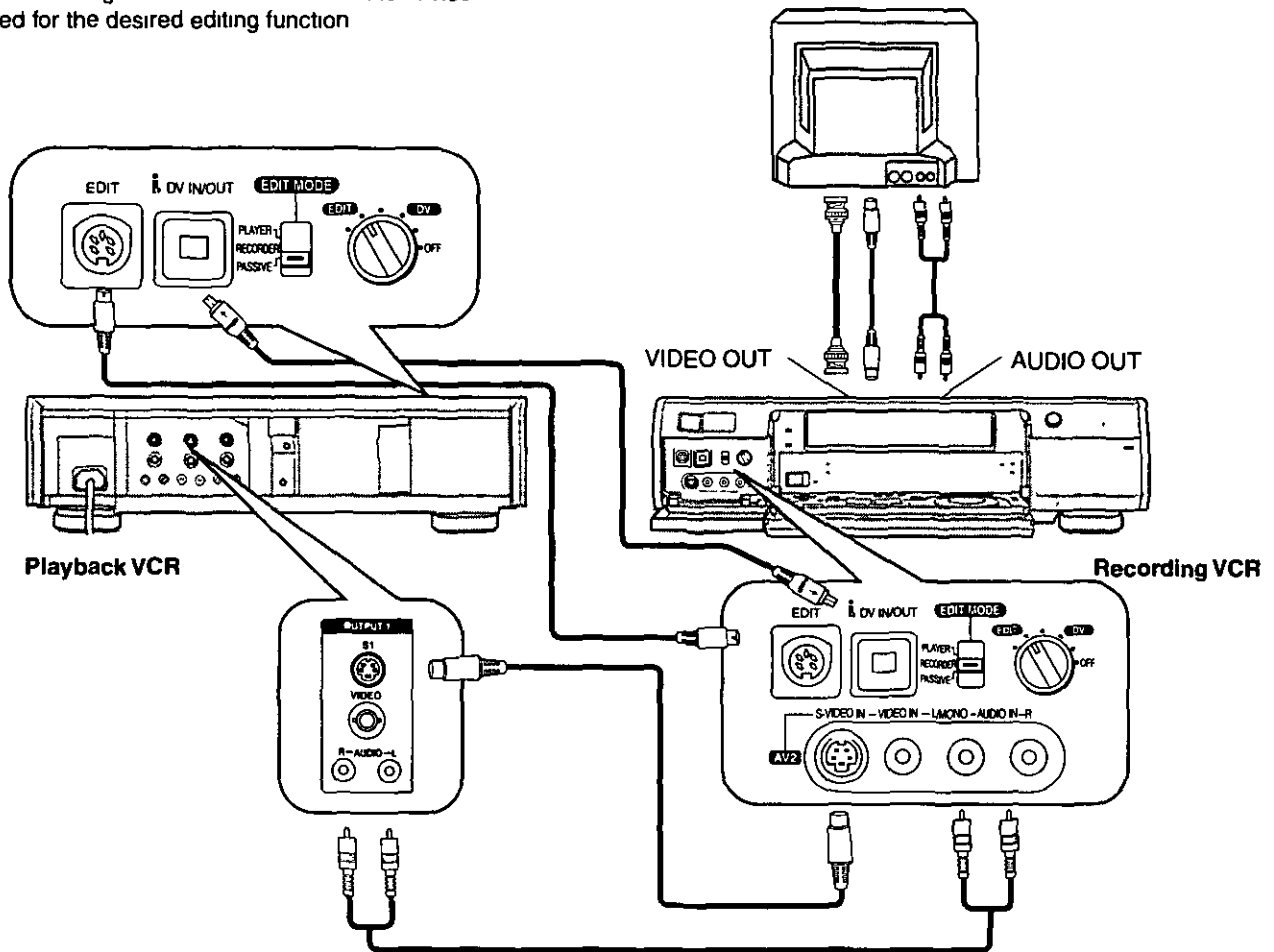

Notes

- Before connecting any cables, first make sure that the power for both VCRs is off
- Insert a recorded cassette into the playback VCR, and a cassette with the closed record prevention tab into the VCR
- When the units are connected using the DV cable and editing is performed, some editing functions will differ compared with when the units are connected using the AV cable. Refer to Glossary of Terms on page 66
- Use Time codes for program editing when the playback VCR is connected to this unit via only a DV cable
- It is recommended that the DV cable be disconnected for editing with **INPUT SELECT** set to A1 and A2. If **INPUT SELECT** is set to A1 and A2 with the connections shown in the figure left unchanged, the monitor picture may be disturbed or noise may occur (This has no effect on the actual editing operations)
- Do not change the **EDIT CONTROL** or **EDIT MODE** settings while performing setting or editing operations at the SET UP or EDIT MENU screens. Be sure to quit these screens before changing these settings
- When the connections and setting are made as shown above, then
 - The **▷(PLAY)**, **▶▶(FF)**, **REC** and the other such buttons on the playback VCR or the remote controller cannot be used to control the playback VCR directly. In order to permit direct control, set **EDIT CONTROL** on the playback VCR to **OFF**.
- The following editing functions can be used by connecting the playback VCR with a DV cable
 - Copying
 - Video Insert
 - Audio Insert
 - Assemble
 In this case, simply set **INPUT SELECT** to DV IN, and set **EDIT CONTROL** to DV
- When using the BNC socket, use a BNC-PHONO conversion adapter (sold separately)

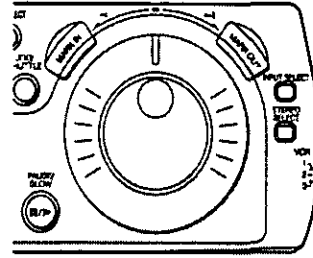
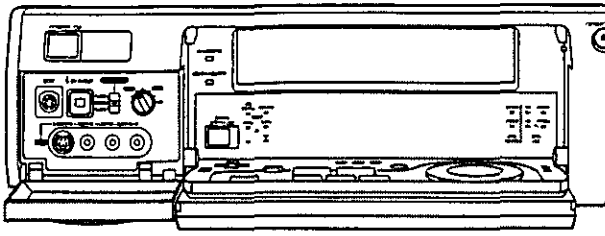

Playback VCR

1 Turn the power on

2 Set **EDIT MODE** to **PASSIVE**.



3 Set **EDIT CONTROL** to **EDIT**.

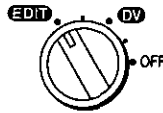

Recording VCR

1 Turn the power on

2 Set the **EDIT MODE** to **RECORDER**.

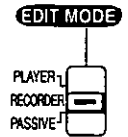

3 Set **EDIT CONTROL** to **EDIT**.

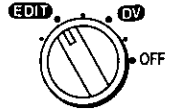

4 Press **INPUT SELECT** so that **DV IN** is selected.

- When performing Audio Dubbing or AV Insert, select A1 or A2

Controlling the Recording VCR through the Playback VCR

Follow the procedure described below

- Connect the edit cable to the **EDIT** socket on both the playback VCR and the recording VCR
- Use AV cables to connect the input sockets on the recording VCR with the output sockets on the playback VCR
- Connect two monitors, one to each of the VCRs, so that the screens from both VCRs can both be seen
- Set **EDIT CONTROL** on both the playback VCR and the recording VCR to **EDIT**.
- Press **INPUT SELECT** on the playback VCR and select a position to which a cable is not connected
- Set **EDIT MODE** on both VCRs as follows
Playback VCR **PLAYER**
Recording VCR **PASSIVE**

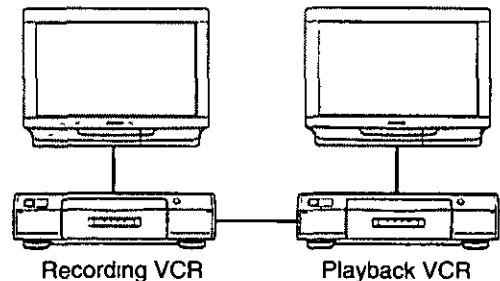

Notes:

- When this connection is made, the recording VCR cannot be controlled using the DV cable
- Although noise may appear on the screen, depending on the connections, the noise has no effect on the actual editing operations
- Audio Insert and AV Insert are not possible in this configuration
- When performing editing with this connection, the editing accuracy may be worse than when controlled from the recording VCR



Connecting an S-VHS (VHS) Video Equipment with an Edit Socket

Example for connecting an S-VHS (VHS) Video Equipment with an Edit socket as the playback unit, when controlling the playback unit through the recording VCR (this unit)

Refer to the diagram below and connect the cables required for the desired editing function

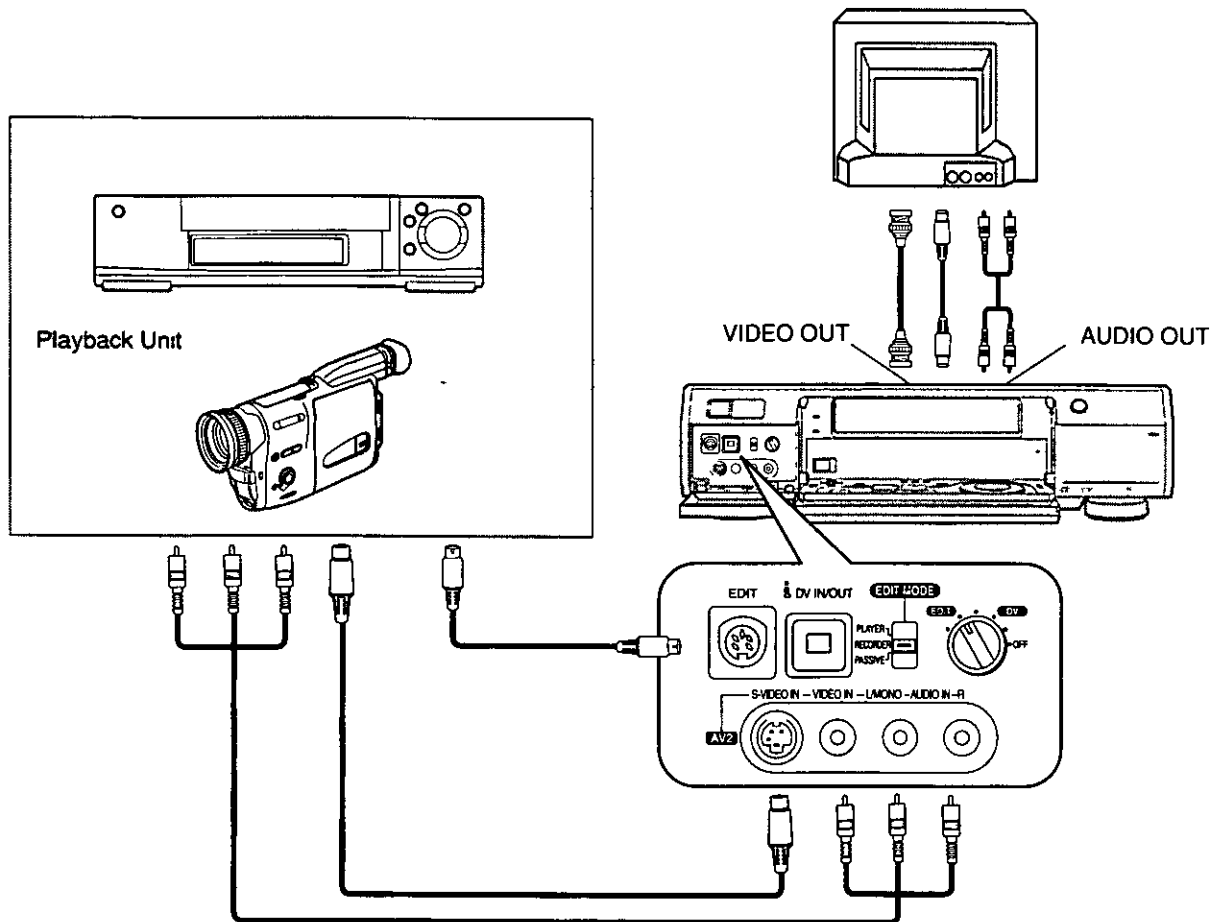

Notes:

- Before connecting any cables, first make sure that the power for both units is off
- Insert a recorded cassette into the playback unit, and a cassette with the closed record prevention tab into the VCR
- If the playback unit is connected to the recording unit via an S-VIDEO cable, the video signal on the S-VIDEO cable takes priority. If the playback unit does not have an S-VIDEO socket do not connect the S-VIDEO cable to this unit
- Read the operating instructions of the playback unit
- Do not change the **EDIT CONTROL** or **EDIT MODE** settings while performing setting or editing operations at the SET UP or EDIT MENU screens. Be sure to quit these screens before changing these settings
- When using this VCR as the recording VCR, the On Screen Display (date/time, Time Code) may scroll vertically when still playback or slow playback are performed by the playback VCR
- When using the BNC socket, use a BNC-PHONO conversion adapter (sold separately)

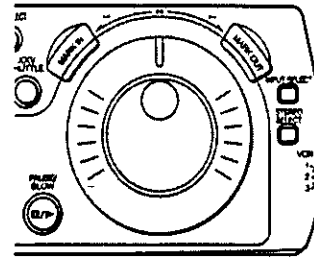
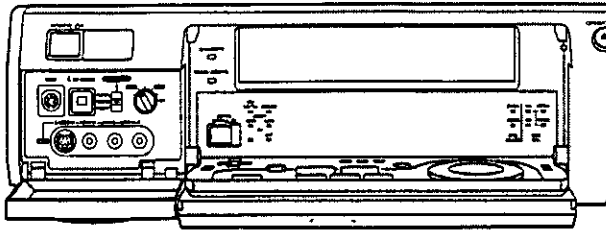

Playback Unit (S-VHS (VHS) Video Equipment with an Edit socket)

- 1 Turn the power on.
- 2 Set the unit so that it is ready to be controlled
 - Read the operating instructions of the playback unit and make the necessary settings

Recording VCR (this unit)

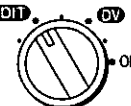
- 1 Turn the power on
- 2 Set **EDIT MODE** to **RECORDER**.
 
- 3 Set **EDIT CONTROL** to **EDIT**.
 
- 4 Press **INPUT SELECT** so that A2 is selected
 - If the playback unit is connected to the external input on the rear of this unit, select A1

Connecting this unit as the Playback VCR to an S-VHS (VHS) VCR

Follow the procedure described below

- Connect the edit cable to the **EDIT** socket on both the playback VCR and the recording VCR
- Use AV cables to connect the output sockets on this unit with the input sockets on the S-VHS (VHS) VCR
- Connect two monitors, one to this VCR and one to the S-VHS (VHS) VCR, so that the screens from both VCRs can both be seen
- Set **EDIT CONTROL** on this unit to **EDIT**
- Set **EDIT MODE** on this unit to **PLAYER**
- Press **INPUT SELECT** on this unit and select a position to which a cable is not connected
- Make the necessary editing control settings for the S-VHS (VHS) VCR (Read the operating instructions of S-VHS (VHS) VCR)

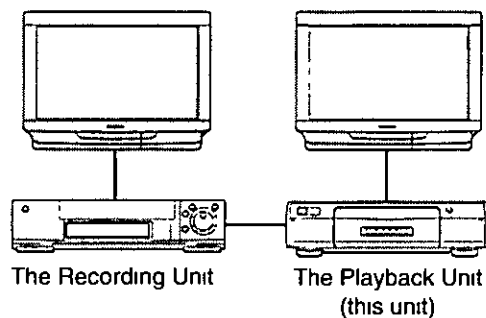

Note:
Audio Insert and AV Insert are not possible in this configuration



Initial Settings for Editing

This VCR also allows some settings for editing to be made at the On Screen Display (OSD)

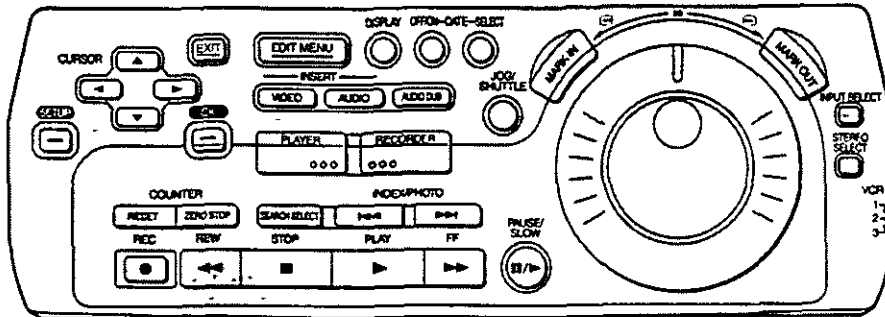

Preparations

- Confirm that the monitor is on and the VCR viewing channel is selected
- Complete necessary connections and settings
See pages 24-29

Search with Sound

1 Press SET UP



2 Select Search With Sound

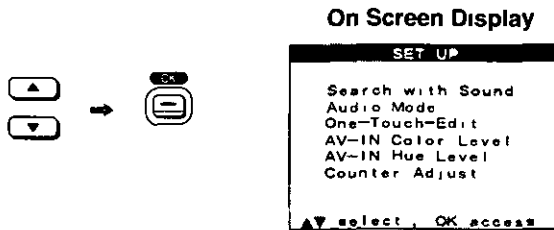

3 Select OFF, EDIT ONLY or ALWAYS ON

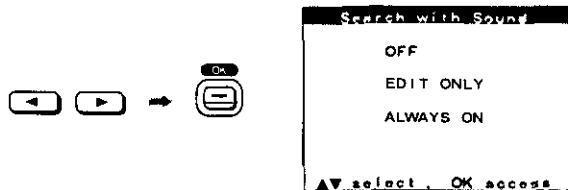

- OFF** The sound cannot be heard during special playback
- EDIT ONLY** The sound can be heard during special playback only when an editing operation is in progress
- ALWAYS ON** The sound can be always heard during special playback

4 Press EXIT to exit the On Screen Display

Audio Mode

1 Press SET UP.



2 Select Audio Mode

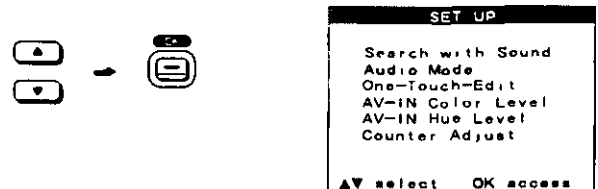

3 Select 12bit or 16bit

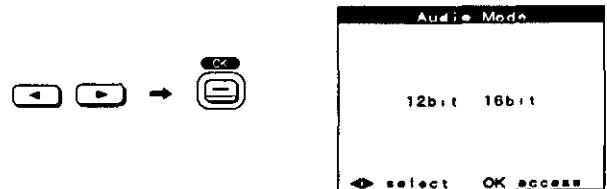

- 12bit** Divides the audio area into two stereo audio tracks, STEREO1 and STEREO2
 - If a recording is made in 12bit audio mode, the sound is recorded on STEREO1 only, and is not recorded on STEREO2. STEREO2 is used to record new audio that is added through Audio Dubbing or Audio Mixing
- 16bit** Uses the entire audio area in order to record audio with greater quality

4 Press EXIT to exit the On Screen Display

One-Touch-Edit

1 Press **SET UP**



2 Select **One-Touch-Edit**.

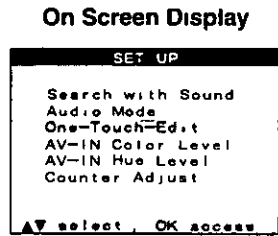

3 Select **OFF** or **ON**

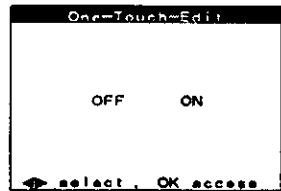

OFF Select this whenever you are performing any editing function other than One-Touch-Edit

ON Select this in order to perform One-Touch-Edit

• One-Touch-Edit is possible only when **EDIT CONTROL** is set to either **DV** or **EDIT**, and **EDIT MODE** is set to **RECORDER**

4 Press **EXIT** to exit the On Screen Display

AV-IN Color Level

1 Press **SET UP**



2 Select **AV-IN Color Level**

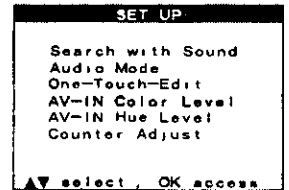
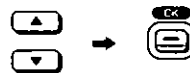

3 Select **SOURCE** or **ADJUST**.

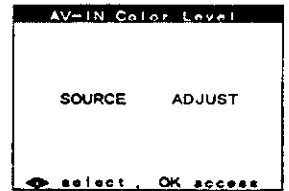

SOURCE Normally set this position

ADJUST To adjust the color level of the input external recording source connected to A1 or A2

If you select **ADJUST** and then press **OK**, the AV-IN Color Level screen is displayed

4 Adjust the color level using ◀▶

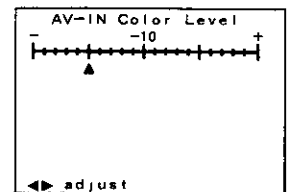

Press ◀ to make the color lighter

Press ▶ to make the color darker

The setting can be adjusted over a range of ± 20

5 Press **SET UP**, and then press **EXIT** to exit the On Screen Display

Notes:

- If **INPUT SELECT** is set to DV IN, the Audio Mode, AV-IN Color Level, and AV-IN Hue Level cannot be selected on SET UP screen
- The AV-IN Color Level and AV-IN Hue Level can be selected in following cases
INPUT SELECT is set to A1 or A2,
When the VCR is in stop mode



AV-IN Hue Level

1 Press **SET UP**.



2 Select **AV-IN Hue Level**.

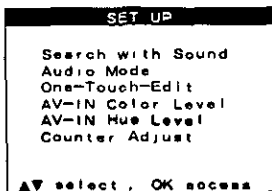

3 Select **SOURCE** or **ADJUST**.

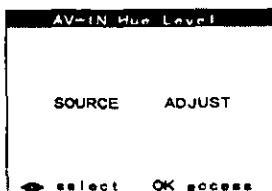

SOURCE Normally set this position
ADJUST To adjust the hue level of the input external recording source connected to A1 or A2

If you select **ADJUST** and then press **OK**, the AV-IN Hue Level screen is displayed

4 Adjust the hue level using ◀▶

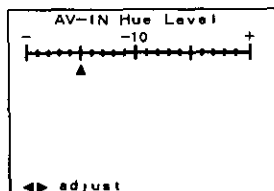

Press ◀ to make the hue redder
 Press ▶ to make the hue greener
 The setting can be adjusted over a range of ± 20

5 Press **SET UP**, and then press **EXIT** to exit the On Screen Display

Counter Adjustment

1 Press **SET UP**



2 Select **Counter Adjust**.

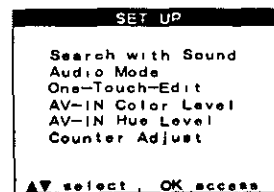

3 Select **ON** or **OFF**.

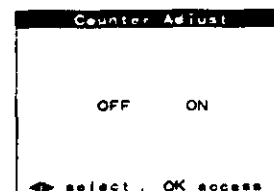

ON When the counter mode of the connected unit is set to "DV Time code"
OFF When a non-digital video equipment is connected
 Also use this setting if a digital video equipment is connected but that VCR's counter mode is set to tape counter display

4 Press **EXIT** to exit the On Screen Display

Notes

- If **INPUT SELECT** is set to DV IN, the Audio Mode, AV-IN Color Level, and AV-IN Hue Level cannot be selected on SET UP screen
- The AV-IN Color Level and AV-IN Hue Level can be selected in following cases
INPUT SELECT is set to A1 or A2,
 When the VCR is in stop mode
- The Counter Adjustment function operates automatically if a digital video equipment is connected but that tape counter is displayed



Creating the Tapes For Editing

In order to operate editing functions correctly, use these tapes for editing as follows:

- **Tape on which the picture and sound have been recorded properly for about 20 seconds prior to the edit start point** [Playback unit] [Recording unit]
This VCR first rewinds the tape to the section prior to the edit start point and then commences editing. For this reason, accurate editing cannot be performed if the tape has been left blank or if the picture and sound have not been recorded properly for 20 seconds prior to the edit start point.
- **Tape on which the Time code has been recorded continuously** [Playback unit] [Recording unit]
If the recording is broken up or if the tape is blank in places, the Time code will lack continuity, and editing will be aborted.
- **Tape which was recorded in SP mode** [Recording unit]
(This applies to Insert, Audio Dubbing and Audio Mixing only)
The above types of editing operations cannot be performed on a tape which was recorded in the LP mode.
- **Tape which was recorded in the 12bit audio mode** [Recording unit]
(This applies to AV Insert, Audio Dubbing and Audio Mixing editing only)
The above types of editing operations cannot be performed on a tape which was recorded in the 16bit audio mode.

When a tape which was recorded on another video recorder is used for Insert, Audio Dubbing or Audio Mixing editing operations, the sound may deteriorate and the picture may be disturbed.

If tapes answering to the above description are not available, proceed with dubbing by following the steps below to create the tapes for editing.

- 1 Load the original cassette tape into the playback unit and the new cassette tape into the recording VCR (this VCR)
- 2 Connect the playback unit and recording VCR (this VCR)
For the connection, use the DV cable when the contents of the original cassette are to be copied using their original digital signals, and use the AV cable when the contents are to be copied using the signals from the video and audio sockets
(To dub a 16bit audio tape and make a 12bit audio tape, connect the units using the AV cables, and proceed with the dubbing.)
- 3 Check that **EDIT CONTROL** is at the **OFF** position
- 4 Set the VCR's tape speed to **SP**
- 5 Record a blank picture for about 20 seconds
Set the playback unit to the stop mode, set **INPUT SELECT** on the recording VCR (this VCR) to **A2** and start recording
- 6 Switch over the input of the recording VCR (this VCR)
If the DV cable was used for the connection in step 2, switch over to "DV IN", if the AV cable was used, switch over to **A1** or **A2**
- 7 Press the play button on the playback unit to start playing the original tape
- 8 Press **REC** on the recording VCR (this VCR) to start dubbing

Notes

- Digital copying using a DV cable yields a picture quality which undergoes hardly any deterioration at all
- If a digital video tape is dubbed without connecting the DV cable, the original sub code data (Photoshot index signals, date information, etc.) will not be copied
- The Time code is simultaneously recorded over the sub code of the tape when the tape is recorded. Also recorded in the sub code are the photoshot index signals, information on the recording date, etc.
For further details on the Time code, see page 66





Editing when Not Using an Edit Cable

To connect a VCR or Movie Camera without an Edit Socket and use this unit as the Recording VCR

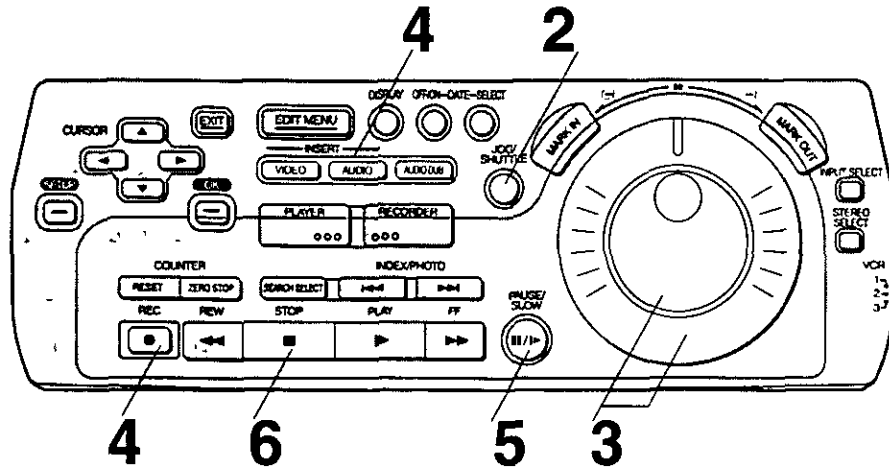

Preparations

- Complete necessary connections and settings
See pages 24-33
- Connect the INPUT1 or AV2 on this unit to the playback unit
Set **INPUT SELECT** on this VCR
A1 Through the INPUT1 sockets
A2 Through the AV2 sockets
- If the playback unit has a DV terminal, connect to the DV IN/OUT on this unit with a DV cable

Operations

1 Using the controls on the playback unit, search for the edit start point, and then pause the playback

2 Press **JOG/SHUTTLE** on this unit, and check that the button is lit.



3 Search for the edit start point

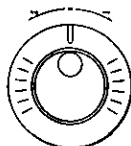

4 Press the button for the editing mode on this unit.

To copy the contents of the tape in the playback unit as is Press **REC**.

To insert picture Press **VIDEO INSERT**.

To insert sound Press **AUDIO INSERT**

To insert picture and sound Press **VIDEO INSERT** and then press **AUDIO INSERT** (or vice versa)

To add new sound Press **AUDIO DUB**.

For Audio Mixing Press **AUDIO DUB** and then press **MIXING EDIT** on the front right panel

- The Audio Mixing procedure differs in part from other editing operations See page 40

- The indicator that corresponds to the selected editing mode lights on the VCR display

Indicators On the VCR Display

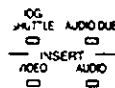

VIDEO INSERT

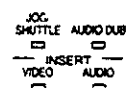

AUDIO INSERT

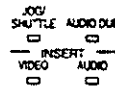

AV INSERT

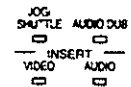

AUDIO DUBBING
AUDIO MIXING

-
- 5** Press **PAUSE/SLOW** on this unit and start playback on the playback unit simultaneously
- Editing begins

-
- 6** Press **■(STOP)** on this unit, and then press **STOP** on playback unit to stop editing
-

Notes:

- Although Copying can be performed in LP mode, Insert and Audio Dubbing cannot be performed with a tape recorded in LP mode. It is necessary to first copy the tape in SP mode
- **Video Insert and Audio Insert are not possible in the following cases**
When the tape in the recording VCR (this unit) is
Recorded in LP mode,
Blank, or contains a blank portion in the middle
- **AV insert, Audio Dubbing and Audio Mixing are not possible in the following cases.**
When the tape in the recording VCR (this unit) is
Recorded in 16bit audio mode,
Recorded in LP mode,
Blank, or contains a blank portion in the middle
When **INPUT SELECT** is set to DV IN
- If the time display on this unit is set to tape counter mode during editing, this unit stops the editing operation automatically when the counter reaches "0 00 00"
(This function does not work when using the Copying or Audio Dubbing functions)

One-Touch Assemble

If the One-Touch Edit function is used, Assemble editing can be performed by controlling the playback unit through this unit

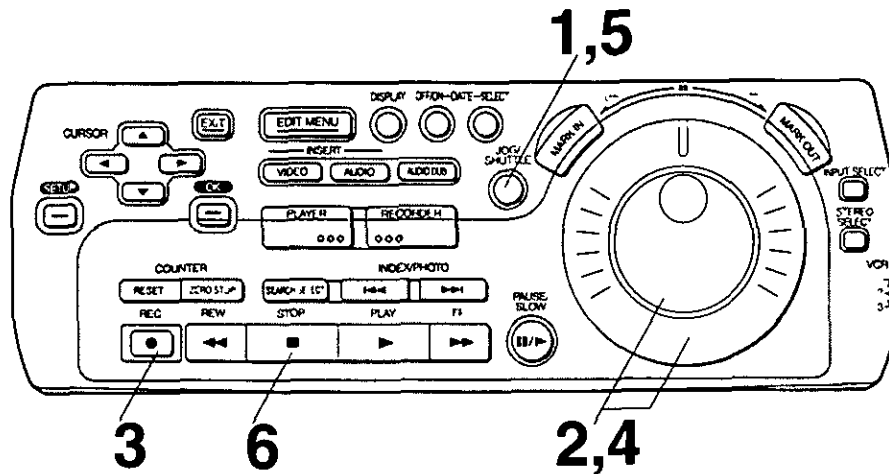

Preparations

- Complete necessary connections and settings
See pages 24-33
- Set **One-Touch-Edit** to **ON** on SET UP menu

Operations

- 1** Press **JOG/SHUTTLE** on this unit, and check that the button is lit



- 2** Search for the edit start point on this unit

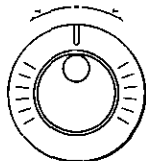

- 3** Press **REC**.
- The picture from the playback unit appears on the screen

- 4** Search for the edit start point on the playback unit using Jog dial and Shuttle Ring on this unit

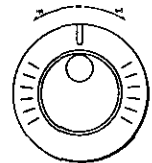

- 5** Press **JOG/SHUTTLE** on this unit
- Editing begins
 - To continue editing, press **JOG/SHUTTLE** on this VCR, and repeat steps 4-5



- 6** Press **■(STOP)** on this unit to stop editing

Notes

- Although Assemble editing can be performed in LP mode, Insert, Audio Dubbing, and Audio Mixing cannot be performed with a tape recorded in LP mode. It is necessary to first copy the tape in SP mode.
- In order to ensure that the editing operation is performed properly, the editing points should be set at least 20 seconds after the beginning of the tape.
- When using the editing controller for remote control
In order to conserve battery power, **JOG/SHUTTLE** turns off after one minute.
If **JOG/SHUTTLE** turns off after the edit start point has been set on the recording unit (step 2), it is necessary to press **JOG/SHUTTLE** again (so that it is lit) before searching for the edit start point on the playback unit.
If **JOG/SHUTTLE** turns off after the edit start point has been determined on the playback unit (step 4), it is necessary to press **JOG/SHUTTLE** twice in order to start editing.

One-Touch Insert/Audio Dubbing

If the One-Touch Edit function is used, Insert (Video Insert, Audio Insert, and AV Insert) and Audio Dubbing can be performed by controlling the playback unit through this unit

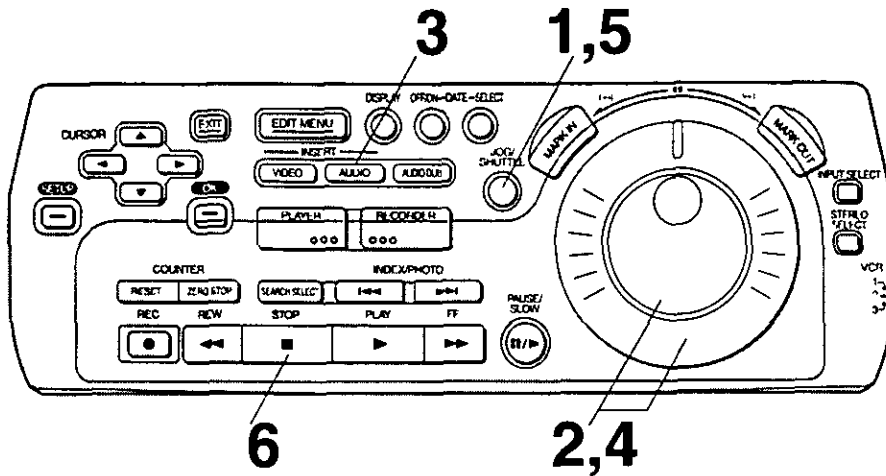

Preparations

- Complete necessary connections and settings
See pages 24-33
- Set to **One-Touch-Edit ON** on SET UP menu

Operations

1 Press **JOG/SHUTTLE** on this unit, and check that the button is lit



2 Search for the edit start point on this unit

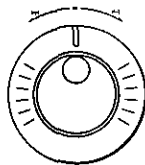

3 Press the button for the editing mode on this unit

- To insert picture Press **VIDEO INSERT**.
- To insert sound Press **AUDIO INSERT**
- To insert picture and sound Press **VIDEO INSERT** and then press **AUDIO INSERT** (or vice versa)
- To add new sound Press **AUDIO DUB**

- The indicator that corresponds to the selected editing mode lights on the VCR display
- The picture from the playback unit appears on the screen

Indicators On the VCR Display

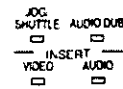

VIDEO INSERT

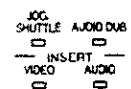

AUDIO INSERT

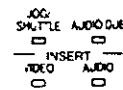

AV INSERT

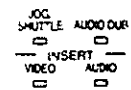

AUDIO DUBBING

.....

4 Search for the edit start point on the playback unit using Jog dial and Shuttle Ring on this unit

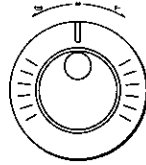

.....

5 Press **JOG/SHUTTLE** on this unit

- Editing begins
- To continue editing, press **JOG/SHUTTLE** on this VCR, and repeat steps 4-5



.....

6 Press **■(STOP)** on this unit to stop editing

.....

To monitor the edited audio after Audio Dubbing

Press **STEREO SELECT** during playback and select **STEREO2**

Notes.

- **Video Insert and Audio Insert are not possible in the following cases:**
When the tape in the recording VCR (this unit) is Recorded in LP mode, Blank, or contains a blank portion in the middle
- **AV Insert and Audio Dubbing are not possible in the following cases**
When the tape in the recording VCR (this unit) is Recorded in 16bit audio mode, Recorded in LP mode, Blank, or contains a blank portion in the middle
When **INPUT SELECT** is set to DV IN
- If the time display on this unit is set to tape counter mode during editing, this unit stops the editing operation automatically when the counter reaches "0 00 00"
- In order to ensure that the editing operation is performed properly, the editing points should be set at least 20 seconds after the beginning of the tape
- When using the editing controller for remote control In order to conserve battery power, **JOG/SHUTTLE** turns off after one minute
If **JOG/SHUTTLE** turns off after the edit start point has been set on the recording unit (step 2), it is necessary to press **JOG/SHUTTLE** again (so that it is lit) before searching for the edit start point on the playback unit
If **JOG/SHUTTLE** turns off after the edit start point has been determined on the playback unit (step 4), it is necessary to press **JOG/SHUTTLE** twice in order to start editing



One-Touch Audio Mixing

This function is used to mix the audio on STEREO1, which has already been recorded, with audio from a external recording source (A1 or A2), and record the result on STEREO2

This function is useful for adding new audio, such as music or a narration, to the original audio which has already been recorded

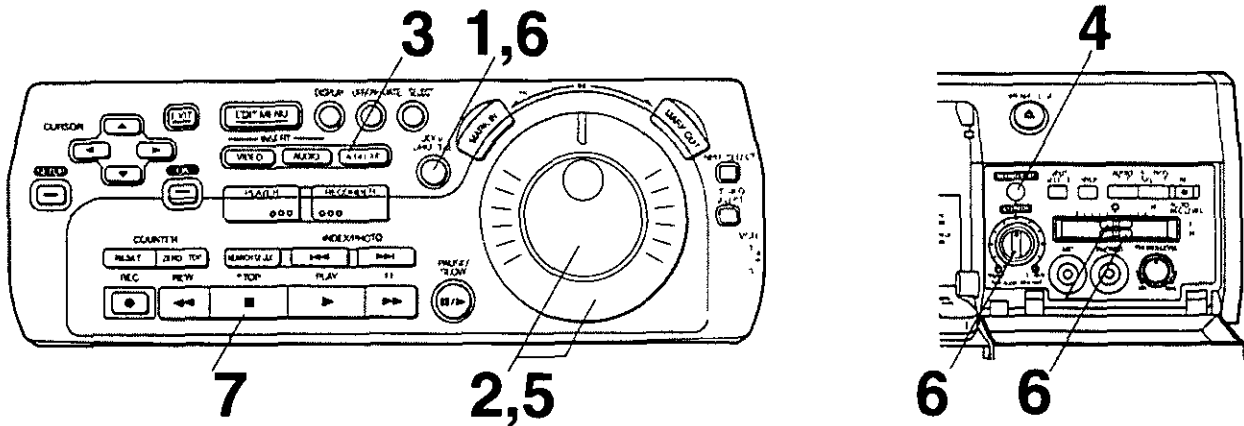

Preparations

- Complete necessary connections and settings
See pages 24-33
- Set to **One-Touch-Edit ON** on SET UP menu

Operations

1 Press **JOG/SHUTTLE** on this unit, and check that the button is lit



2 Search for the edit start point on this unit

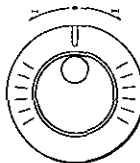

3 Press **AUDIO DUB** on this unit

- The picture from the playback unit appears on the screen

4 Press **MIXING EDIT** on this unit

5 Search for the edit start point on the playback unit using Jog dial and Shuttle Ring on this unit

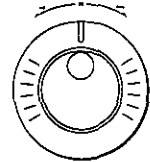

6 Press **JOG/SHUTTLE** on this unit

- Editing begins
- If you wish to adjust the volume of the original audio (STEREO1) and external recording source (A1 or A2) during Audio Mixing, **AUDIO MIX** To adjust the volume of the original audio (STEREO1)
- AUDIO REC LEVEL**
To adjust the volume of the audio from external recording source (A1 or A2)
- To continue editing, press **JOG/SHUTTLE** on this VCR, and repeat steps 5-6.



.....

7 Press **■ (STOP)** on this unit to stop editing

.....

To monitor the mixed signal after Audio Mixing

Press **STEREO SELECT** during playback and select **STEREO2**

Notes

- **Audio Mixing is not possible in the following cases:**
When the tape in the recording VCR (this unit) is
Recorded in 16bit audio mode,
Recorded in LP mode,
Blank, or contains a blank portion in the middle
When **INPUT SELECT** is set to DV IN
- In order to ensure that the editing operation is performed properly, the editing points should be set at least 20 seconds after the beginning of the tape

When editing with a microphone

- 1 Connect the microphone to the MIC socket
- 2 Press **JOG/SHUTTLE**
- 3 Use Jog Dial and Shuttle Ring to search the recording start point
- 4 Press **AUDIO DUB**
- 5 Press **MIXING EDIT**
- 6 Use **AUDIO REC LEVEL** slider to adjust the microphone level
- 7 Press **PAUSE/SLOW**
- 8 Press **■(STOP)** to stop editing

- The audio from the microphone is recorded as monaural audio Use audio cables to connect audio equipment, etc , in order to record in stereo
- If both the MIC socket and the line inputs are connected, the audio from the MIC socket is given priority in recording

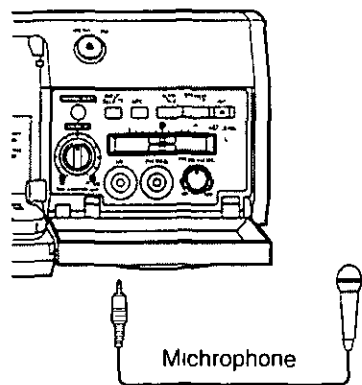



Manual Copying

This function can be used to copy tapes between digital video equipments with practically no deterioration in quality
This function can also copy a tape that was recorded in S-VHS (VHS) format onto a digital video tape

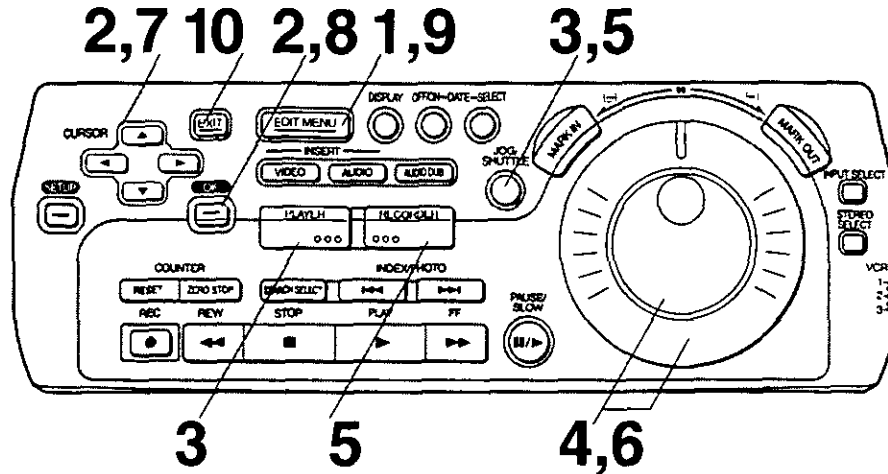

Preparations

- Complete necessary connections and settings
See pages 24-33

Operations

1 Press **EDIT MENU**.



2 Check that **Copying** is selected and press **OK**.



On Screen Display

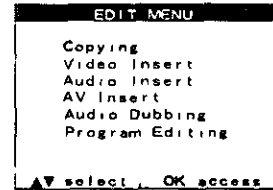

3 Press **PLAYER**, and then press **JOG/SHUTTLE**.

- The picture from the playback unit appears on the screen

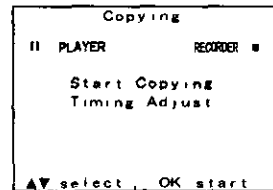

4 Search for the edit start point on the playback unit

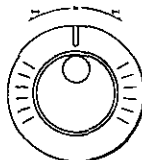

5 Press **RECORDER**, and then press **JOG/SHUTTLE**.

- The picture from the recording VCR appears on the screen



On Screen Display

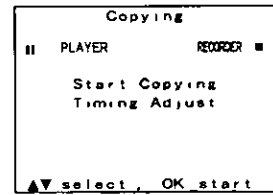

6 Search for the edit start point on the recording VCR

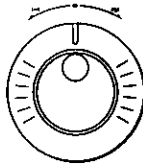

7 Select **Start Copying**.



8 Press **OK**.
• Editing begins



9 Press **EDIT MENU** to stop editing



- Operation now returns to the screen which appears in step 3. This makes it possible to continue with editing or change the point at which editing is to start

10 Press **EXIT**.

- The On Screen Display disappears

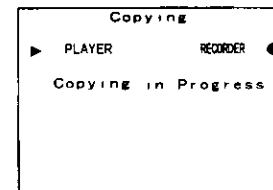

Notes

- If a digital video tape is copied without connecting a DV cable, the original sub code data (photoshot index signals, recording date, etc) is not copied
- Although Copying can be performed in LP mode, Insert and Audio Dubbing cannot be performed with a tape recorded in LP mode. It is necessary to first copy the tape in SP mode
- In order to ensure that the editing operation is performed properly, the editing points should be set at least 20 seconds after the beginning of the tape

- The pause operation may be indicated on the display of the playback unit even though the playback unit is actually playing the tape in slow motion
- Up to ±1 second of slight deviation in the specified edit start position can be corrected. See page 64 for Edit Timing Adjustment





Manual Insert

This function is used to replace the picture and sound on a recorded tape

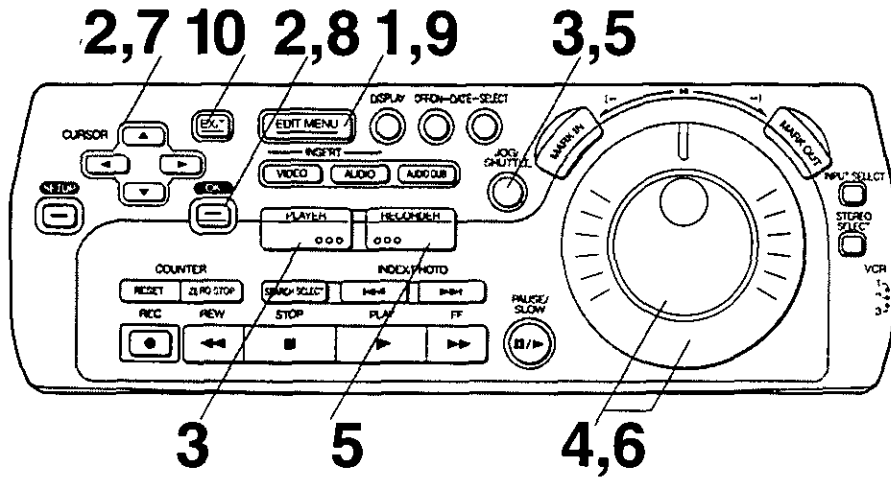

Preparations

- Complete necessary connections and settings
See pages 24-33
- Example: Video Insert

Operations

1 Press **EDIT MENU**. 

2 Select **Video Insert**, and then Press **OK**.
 To insert picture Select **Video Insert**
 To insert sound Select **Audio Insert**
 To insert picture and sound Select **AV Insert**.



On Screen Display

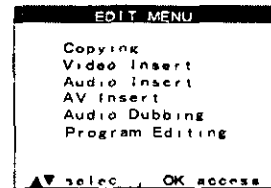

3 Press **PLAYER** and **JOG/SHUTTLE**.
 • The picture from the playback unit appears on the screen

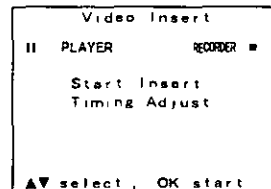
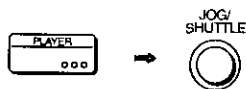

Note

Video Insert and Audio Insert are not possible in the following cases

- When the tape in the recording VCR (this unit) is Recorded in LP mode,
- Blank, or contains a blank portion in the middle

- 4 Search for the edit start point on the playback unit

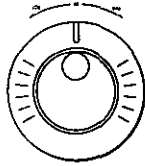

- 5 Press **RECORDER** and **JOG/SHUTTLE**.

- The picture from the recording VCR appears on the screen



- 6 Search for the edit start point on the recording VCR

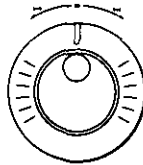

- 7 Select **Start Insert**.



- 8 Press **OK**.
- Editing begins

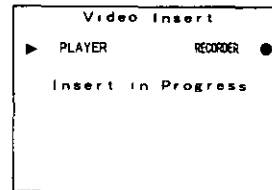

- 9 Press **EDIT MENU** to stop editing



- Operation now returns to the screen which appears in step 3. This makes it possible to continue with editing or change the point at which editing is to start

- 10 Press **EXIT**.
- The On Screen Display disappears



Notes

- AV Insert is not possible in the following cases**

When the tape in the recording VCR (this unit) is
 Recorded in 16bit audio mode,
 Recorded in LP mode,
 Blank, or contains a blank portion in the middle
 When **INPUT SELECT** is set to DV IN

- In order to ensure that the editing operation is performed properly, the editing points should be set at least 20 seconds after the beginning of the tape

- The pause operation may be indicated on the display of the playback unit even though the playback unit is actually playing the tape in slow motion
- Up to ± 1 second of slight deviation in the specified edit start position can be corrected. See page 64 for Edit Timing Adjustment





Manual Audio Dubbing

This function is used to add new sound on the STEREO2 track of previously recorded tape

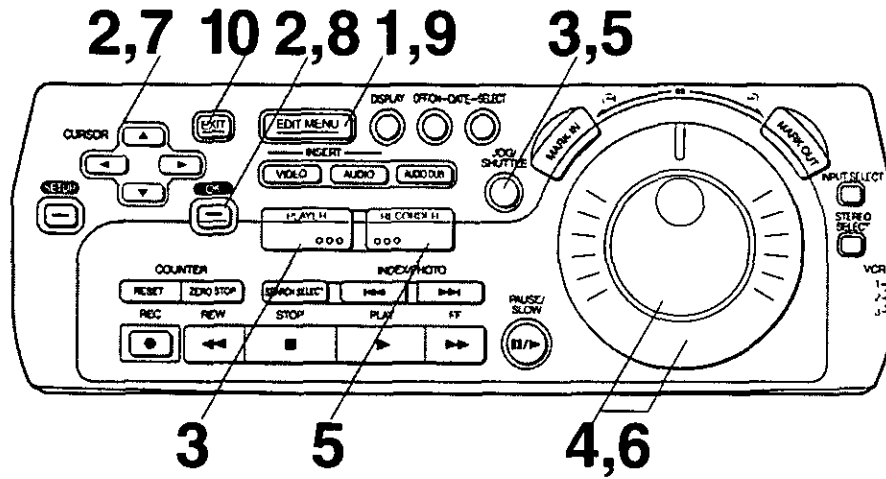

Preparations

- Complete necessary connections and settings
See pages 24-33

Operations

1 Press **EDIT MENU**.



2 Select **Audio Dubbing**, and then Press **OK**.

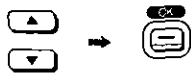

On Screen Display



3 Press **PLAYER** and **JOG/SHUTTLE**.
• The picture from the playback unit appears on the screen

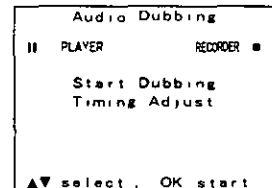

4 Search for the edit start point on the playback unit

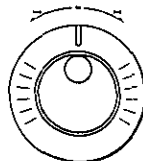

5 Press **RECORDER** and **JOG/SHUTTLE**.

- The picture from the recording VCR appears on the screen.

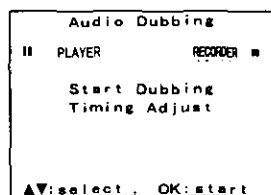
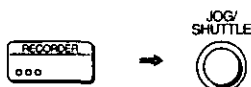

6 Search for the edit start point on the recording VCR.

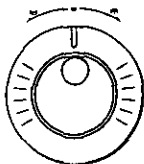

7 Select **Start Dubbing**.



8 Press **OK**.

- Editing begins.

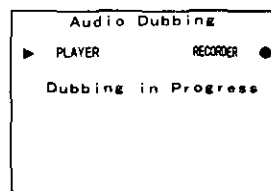

9 Press **EDIT MENU** to stop editing.



- Operation now returns to the screen which appears in step 3. This makes it possible to continue with editing or change the point at which editing is to start.

10 Press **EXIT**.

- The On Screen Display disappears.



To monitor the edited audio after Audio Dubbing

Press **STEREO SELECT** during playback and select **STEREO2**.

Notes:

- **Audio Dubbing is not possible in the following cases:**
 - When the tape in the recording VCR (this unit) is:
 - Recorded in 16bit audio mode;
 - Recorded in LP mode;
 - Blank, or contains a blank portion in the middle.
 - When **INPUT SELECT** is set to DV IN.

- In order to ensure that the editing operation is performed properly, the editing points should be set at least 20 seconds after the beginning of the tape.
- The pause operation may be indicated on the display of the playback unit even though the playback unit is actually playing the tape in slow motion.
- Up to ±1 second of slight deviation in the specified edit start position can be corrected. See page 64 for Edit Timing Adjustment.



Program Assemble

This function can be used to link together desired scenes on a tape

This function can also be used to skip unnecessary scenes recorded on a tape and copy them onto a separate tape

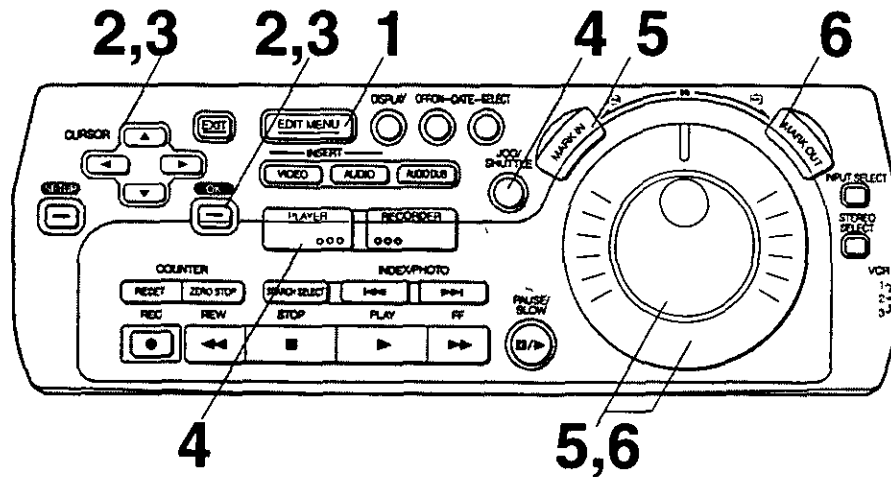

Preparations

- Complete necessary connections and settings
See pages 24-33

Operations

.....

1 Press **EDIT MENU**.



.....

2 Select **Program Editing**, and then Press **OK**.

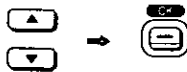

On Screen Display

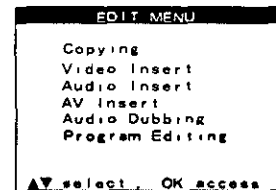

.....

3 Select **Assemble**, and then Press **OK**.

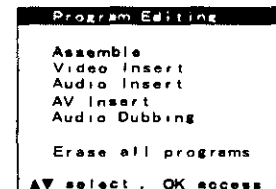
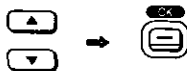

Notes

- Program Editing can be performed using either the tape counter or Time code display, but the Time code display should be used if the units are connected only by a DV cable
- If you attempt to switch to the tape counter display in order to perform editing after setting the editing points using the Time code display, the Erase all programs screen is displayed (The Erase all programs screen is also displayed when you change from the tape counter display to the Time code display)
- After setting a program, if you attempt to set another program in a different editing operation, the set contents for the previous editing operation remain on the setting screen. In order to prevent editing errors, perform the Erase all programs operation (page 61) whenever you set a program under a different editing mode
- Program editing can not be performed with a movie camera that has a 4-digit counter

.....

4 Press **PLAYER** and **JOG/SHUTTLE**.

- The picture from the playback unit appears on the screen



.....

5 Search for the edit start point on the playback unit and press **MARK IN**.

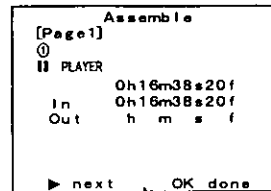
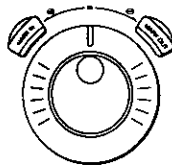

.....

6 Search for the edit end point on the playback unit and press **MARK OUT**.

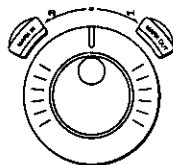

(Continued on next page)

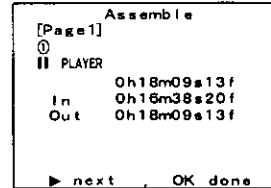

.....

Notes

- Although Assemble editing can be performed in LP mode, Insert, Audio Dubbing, and Audio Mixing cannot be performed with a tape recorded in LP mode. It is necessary to first copy the tape in SP mode.
- In order to ensure that the editing operation is performed properly, the editing points should be set at least 20 seconds after the beginning of the tape.
- The editing operation may not be performed correctly if the set duration of a program is less than 4 seconds.

- On video equipment whose Time code display or tape counter display does not show the frame value, the area where the frame value is displayed appears as "00f" or it remains blank. With some units, the frame value may be displayed when **MARK IN** or **MARK OUT** is pressed in steps 5 and 6 even if the unit concerned does not show the frame value.



Program Assemble (continued)

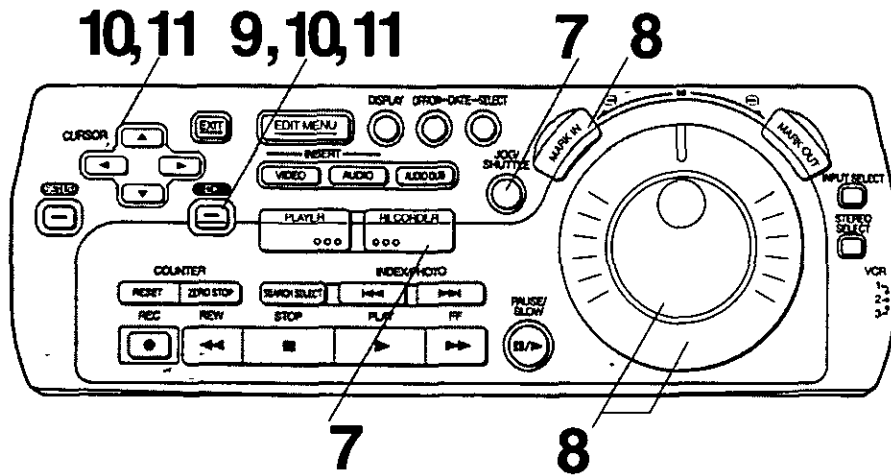

7 Press **RECORDER** and **JOG/SHUTTLE**.

- The picture from the recording VCR appears on the screen



On Screen Display

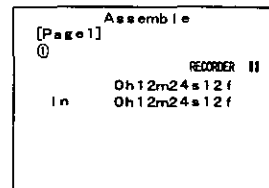

8 Search for the edit start point on the recording VCR and press **MARK IN**.

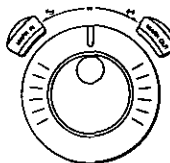

9 Press **OK**.

- "OK. done" is not displayed at the bottom of the screen



To check and change programs

Select **Confirm/Change** and then press **OK**.

- To confirm, change, insert or erase editing programs, see pages 60-61
- Programs cannot be inserted or erased through the recording unit

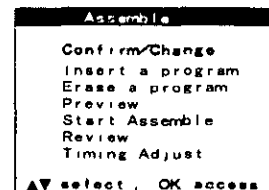

To continue setting programs:

- 1 Press **EDIT MENU**
- 2 Press **PLAYER**.
- 3 Using **◀ ▶**, select the program number
The program number changes each time these buttons are pressed
(Up to 40 programs can be set 10 programs can be set on one page, if this number is exceeded, the display automatically changes to the next page)
- 4 Repeat steps 4-6 and 9

.....

10 Select **Start Assemble** to start editing, and then press **OK**.

- Editing begins after the playback unit and the recording VCR both rewind their tapes to the edit start points

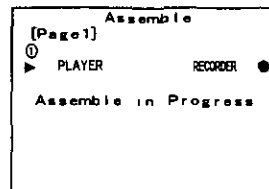

.....

11 After completing editing, select **Review**, and then press **OK**.

- The edited pictures are played back

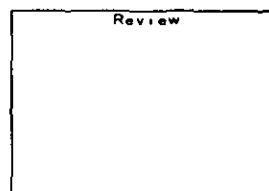

.....

To interrupt editing or Review:
Press **EDIT MENU**.

Notes

- The Preview function cannot be used with the Assemble function
- Up to ± 1 second of slight deviation in the specified edit start/end position can be corrected See pages 62-63 for Edit Timing Adjustment





Program Insert

This function is used to replace the picture and sound on a recorded tape

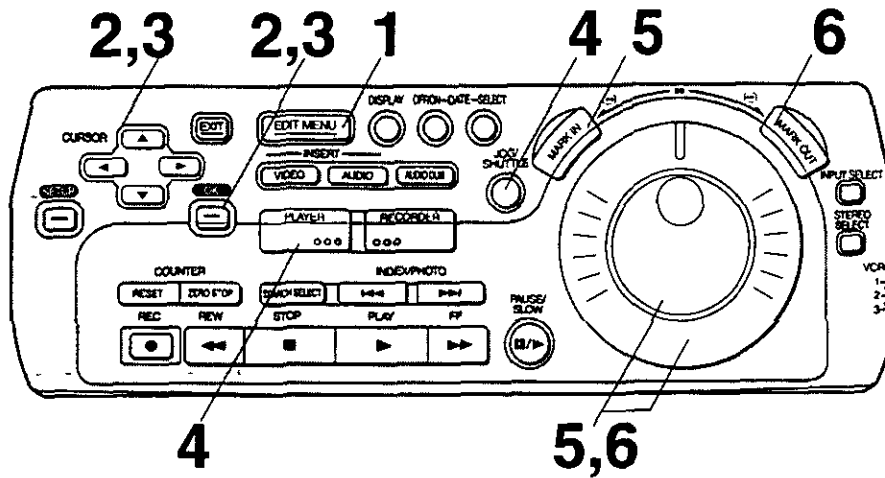

Preparations

- Complete necessary connections and settings
See pages 24-33

Example: Video Insert

Operations

1 Press **EDIT MENU**.



2 Select **Program Editing**, and then Press **OK**.



On Screen Display

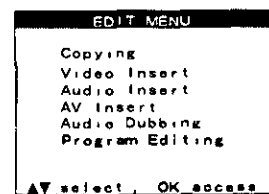

Notes.

- Program Editing can be performed using either the tape counter or Time code display
- If you attempt to switch to the tape counter display in order to perform editing after setting the editing points using the Time code display, the Erase all programs screen is displayed (The Erase all programs screen is also displayed when you change from the tape counter display to the Time code display)
- After setting a program, if you attempt to set another program in a different editing mode, the set contents for the previous editing mode remain on the setting screen. In order to prevent editing errors, perform the Erase all programs operation (page 61) whenever you set a program under a different editing mode
- Program Editing can not be performed with a movie camera that has a 4-digit counter
- **Video Insert and Audio Insert are not possible in the following cases**
When the tape in the recording VCR (this unit) is Recorded in LP mode,
Blank, or contains a blank portion in the middle

3 Select the desired editing operation, and then press **OK**.

To insert picture **Video Insert**.
 To insert sound **Audio Insert**.
 To insert picture and sound **AV Insert**.

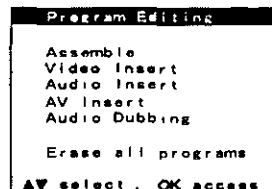

4 Press **PLAYER** and **JOG/SHUTTLE**.

•The picture from the playback unit appears on the screen



5 Search for the edit start point on the playback unit and press **MARK IN**.

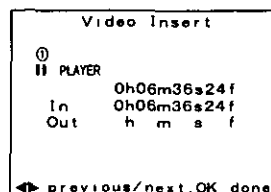
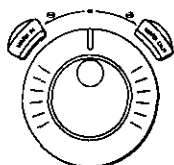

6 Search for the edit end point on the playback unit and press **MARK OUT**.

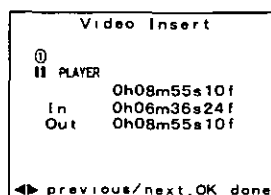
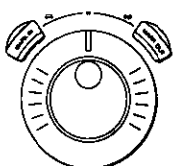

(Continued on next page)

• **AV Insert is not possible in the following cases**

- When the tape in the recording VCR (this unit) is Recorded in 16bit audio mode,
- Recorded in LP mode,
- Blank, or contains a blank portion in the middle
- When **INPUT SELECT** is set to DV IN

Notes on editing point setting

- The Program Insert and Audio Dubbing functions require the setting of only three editing points: the in and out points on the playback unit and the in point on the recording unit, or the in point on the playback unit and the in and out points on the recording unit
- If both in and out points are set on both the playback unit and the recording unit, and the times between the points do not match, editing stops at the first out point that is reached

- In order to ensure that the editing operation is performed properly, the editing points should be set at least 20 seconds after the beginning of the tape
 - The editing operation may not be performed correctly if the set duration of a program is less than 4 seconds
 - On video equipment whose Time code display or tape counter display does not show the frame value, the area where the frame value is displayed appears as "00f" or it remains blank
- With some units, the frame value may be displayed when **MARK IN** or **MARK OUT** is pressed in steps 5 and 6 even if the unit concerned does not show the frame value

Program Insert (continued)

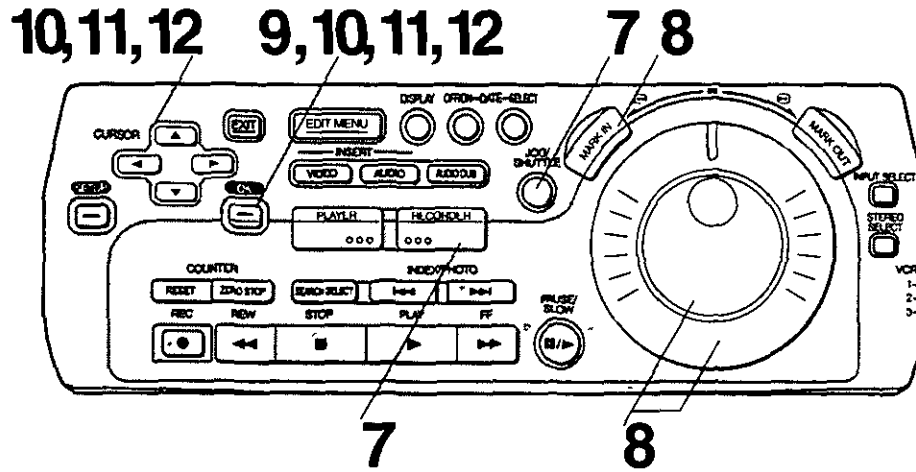

7 Press **RECORDER** and **JOG/SHUTTLE**.

- The picture from the recording VCR appears on the screen



8 Search for the edit start point on the recording VCR and press **MARK IN**.

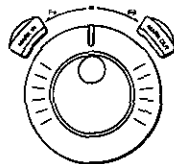

On Screen Display

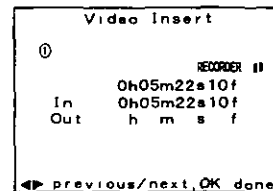

9 Press **OK**.



To check and change programs:

Select **Confirm/Change** and then press **OK**

- To confirm, change, insert or erase editing programs, see pages 60-61

To continue setting programs:

- 1 Press **EDIT MENU**.
- 2 Press **PLAYER**
- 3 Using **◀ ▶**, select the program number
The program number changes each time these buttons are pressed
Up to 10 programs can be set
- 4 Repeat steps 4-9

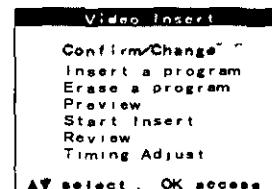

.....

10

Select **Preview** to confirm the editing operation before performing actual editing, and then press **OK**.

- Preview begins after the playback unit and the recording VCR both rewind their tapes to the edit start points

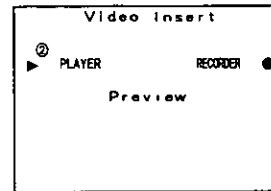

.....

11

Select **Start Insert** to start editing, and then press **OK**.

- Editing begins after the playback unit and the recording VCR both rewind their tapes to the edit start points

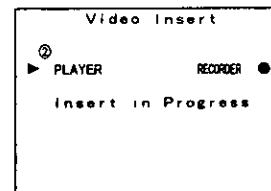
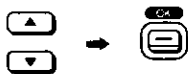

.....

12

After completing editing, select **Review**, and then press **OK**.

- The edited pictures are played back

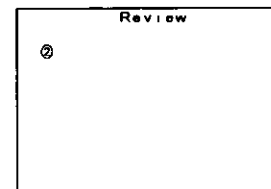
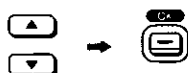

.....

To interrupt editing, Preview or Review:
Press **EDIT MENU**.

Note:
Up to ± 1 second of slight deviation in the specified edit start/end position can be corrected. See pages 62-63 for Edit Timing Adjustment



Program Audio Dubbing

This function is used to add new sound on the STEREO2 track of previously recorded tape

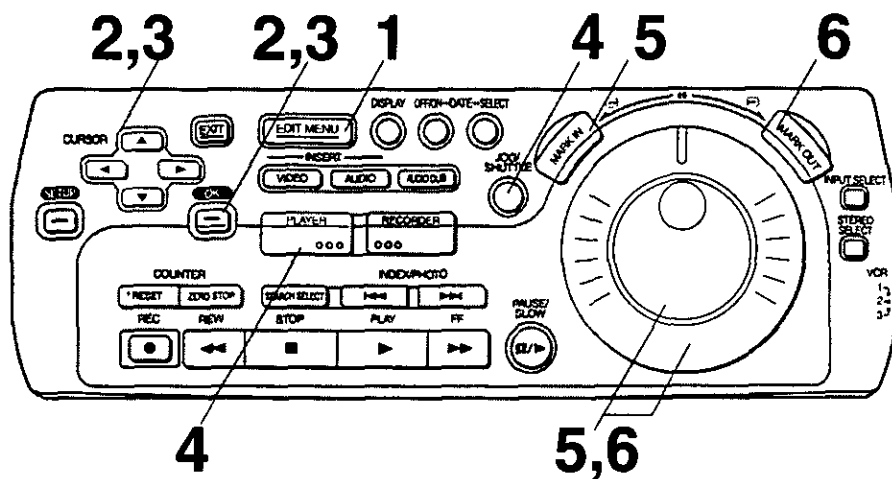

Preparations

- Complete necessary connections and settings
See pages 24-33

Operations

.....

1 Press **EDIT MENU**.



.....

2 Select **Program Editing**, and then Press **OK**.



On Screen Display

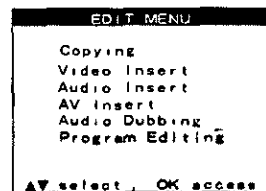

.....

Notes

- Program Editing can be performed using either the tape counter or Time code display
- If you attempt to switch to the tape counter display in order to perform editing after setting the editing points using the Time code display, the Erase all programs screen is displayed
(The Erase all programs screen is also displayed when you change from the tape counter display to the Time code display)
- Program editing can not be performed with a movie camera that has a 4-digit counter
- After setting a program, if you attempt to set another program in a different editing mode, the set contents for the previous editing mode remain on the setting screen. In order to prevent editing errors, perform the Erase all programs operation (page 61) whenever you set a program under a different editing mode
- **Audio Dubbing is not possible in the following cases**
When the tape in the recording VCR (this unit) is
Recorded in 16bit audio mode,
Recorded in LP mode,
Blank, or contains a blank portion in the middle
When **INPUT SELECT** is set to DV IN

.....

3 Select **Audio Dubbing**, and then press **OK**.

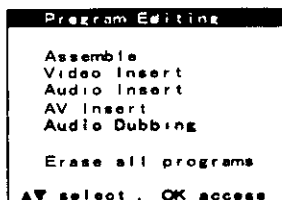
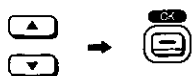

.....

4 Press **PLAYER** and **JOG/SHUTTLE**.

- The picture from the playback unit appears on the screen



.....

5 Search for the edit start point on the playback unit and press **MARK IN**.

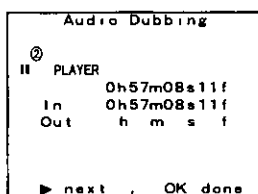
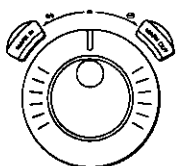

.....

6 Search for the edit end point on the playback unit and press **MARK OUT**.

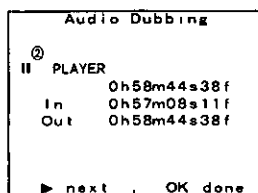
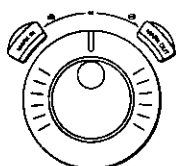

(Continued on next page)

.....

Notes on editing point setting

- The Program Insert and Audio Dubbing functions require the setting of only three editing points: the in and out points on the playback unit and the in point on the recording unit, or the in point on the playback unit and the in and out points on the recording unit
- If both in and out points are set on both the playback unit and the recording unit, and the times between the points do not match, editing stops at the first out point that is reached
- In order to ensure that the editing operation is performed properly, the editing points should be set at least 20 seconds after the beginning of the tape

- The editing operation may not be performed correctly if the set duration of a program is less than 4 seconds
- On video equipment whose Time code display or tape counter display does not show the frame value, the area where the frame value is displayed appears as "00f" or it remains blank
With some units, the frame value may be displayed when **MARK IN** or **MARK OUT** is pressed in steps 5 and 6 even if the unit concerned does not show the frame value

Program Audio Dubbing (continued)

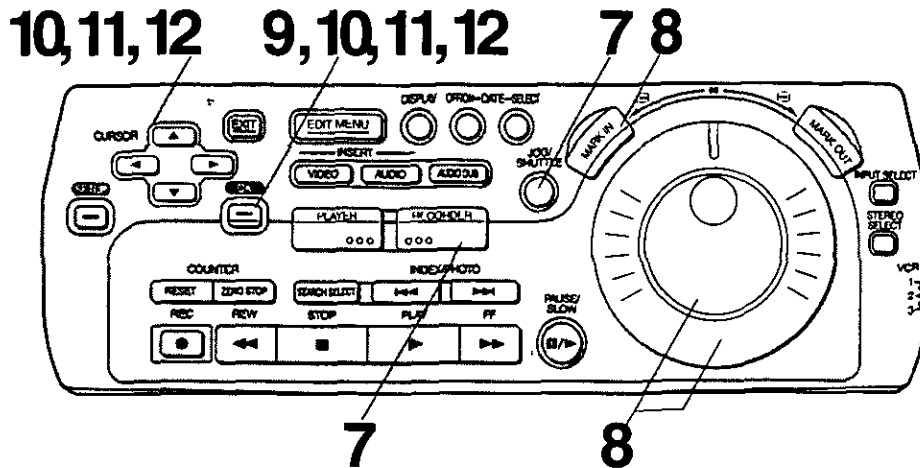

7 Press **RECORDER** and **JOG/SHUTTLE**.

- The picture from the recording VCR appears on the screen



8 Search for the edit start point on the recording VCR and press **MARK IN**.

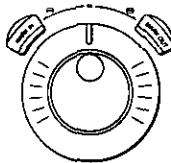

On Screen Display

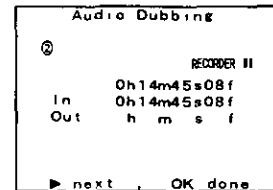

9 Press **OK**.



To check and change programs:

- Select **Confirm/Change** and then press **OK**
- To confirm, change, insert or erase editing programs, see pages 60-61

To continue setting programs:

- 1 Press **EDIT MENU**
- 2 Press **PLAYER**
- 3 Using **◀ ▶**, select the program number
The program number changes each time these buttons are pressed
Up to 10 programs can be set
- 4 Repeat steps 4-9

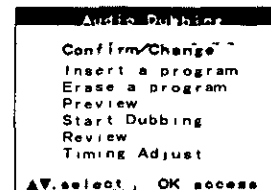

.....

10 Select **Preview** to confirm the editing operation before performing actual editing, and then press **OK**.

- Preview begins after the playback unit and the recording VCR both rewind their tapes to the edit start points

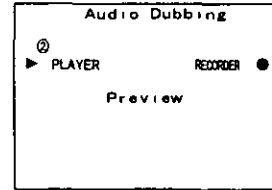

.....

11 Select **Start Dubbing** to start editing, and then press **OK**.

- Editing begins after the playback unit and the recording VCR both rewind their tapes to the edit start points

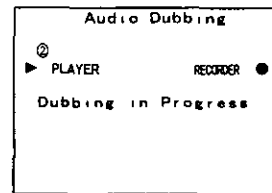

.....

12 After completing editing, select **Review**, and then press **OK**.

- The edited sounds are played back

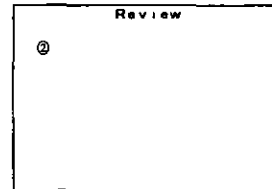

.....

To interrupt editing, Preview or Review:
Press **EDIT MENU**.

To monitor the edited audio after Audio Dubbing

Press **STEREO SELECT** during playback and select **STEREO2**

Note

Up to ± 1 second of slight deviation in the specified edit start/end position can be corrected. See pages 62-63 for Edit Timing Adjustment



Other Editing Functions

These functions are used to confirm, change, etc programs

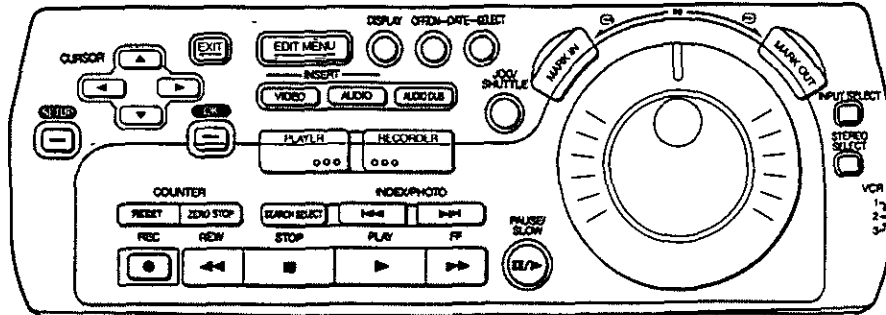

Once all program settings are completed, the screen shown at right is displayed.

Example: Video Insert

On Screen Display

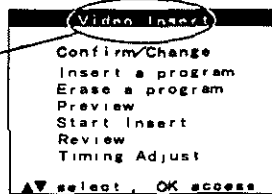

This portion varies, depending on the editing function that was programmed

To check/change programs:

- 1 Select **Confirm/Change**, and then press **OK**
 - The program list for the playback unit is displayed

To check the program list for the recording unit, press **RECORDER**

To just confirm the program settings, press **EDIT MENU**.

If corrections are needed, continue with the procedure described below
- 2 Select the program number for which changes are to be made, and then press **OK**
 - The Program Change screen for the selected program number is displayed
- 3 Press **JOG/SHUTTLE**
- 4 Use the Jog Dial/Shuttle Ring to search for the editing point that is to be corrected
- 5 To change an edit start point, press **MARK IN**
To change an edit end point, press **MARK OUT**.
- 6 Once all changes are completed, press **OK**
- 7 Press **EDIT MENU**.

On Screen Display

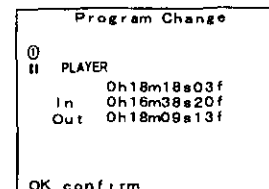
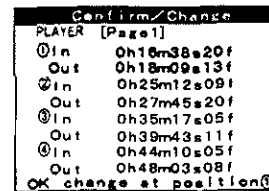
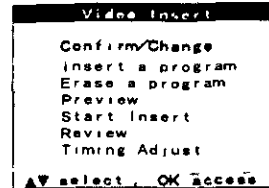

.....
To insert a new program between existing programs:

- 1 Select **Insert a program**, and then press **OK**
 ●The program list is displayed
- 2 Select the program number where a program is to be inserted, and then press **OK**.
 ●The Insert a program screen is displayed
- 3 Refer to the pages that describe the Program Editing functions (on pages 48-59), and set the new program
- 4 When setting is complete, press **OK**.
- 5 Press **EDIT MENU**.

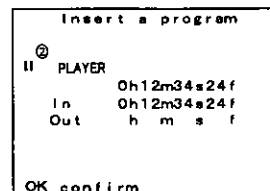
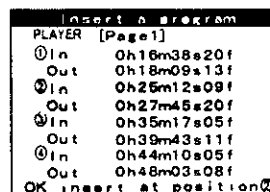

.....
To cancel a program:

- 1 Select **Erase a program**, and then press **OK**.
 ●The program list is displayed
- 2 Select the program number to be erased, and then press **OK**
- 3 Press **EDIT MENU**.

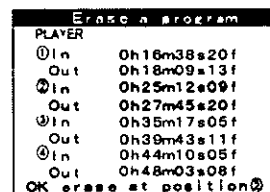

.....
To cancel all editing programs

- 1 Press **EDIT MENU** twice
- 2 Select **Program Editing**, and then press **OK**.
- 3 Check that **Erase all programs** is selected and press **OK**
 ●The Erase all programs screen is displayed
- 4 Select **YES**, and then press **OK**
 ●The screen returns to the Program Editing menu
 ●After the message indicating that "All programs have been erased" appears on the screen, operation returns to the EDIT MENU screen
- 5 Press **EDIT MENU**.

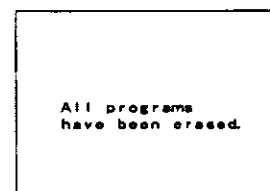
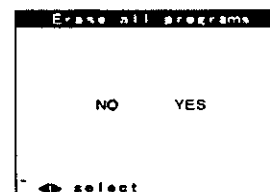
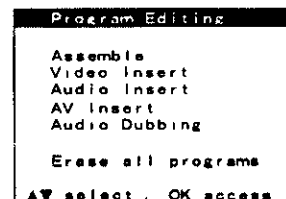

If the EDIT MENU screen is cancelled before the above procedure is performed, the method for displaying the Program Editing changes
 Press **EDIT MENU** so that the EDIT MENU screen is displayed Use to select **Program Editing**, and then press **OK**

.....

Note
 Programs set in the recording unit for the Assemble editing function cannot be inserted or erased

Edit Timing Adjustment

When performing editing in conjunction with a unit which has a different mechanism, there may be a lag in the edit start point due to a deviation between the time a pause cancellation signal is received by the recording unit and the time recording actually begins

Edit Timing Adjustment is used to compensate the edit start and end time in light of this start-up time deviation

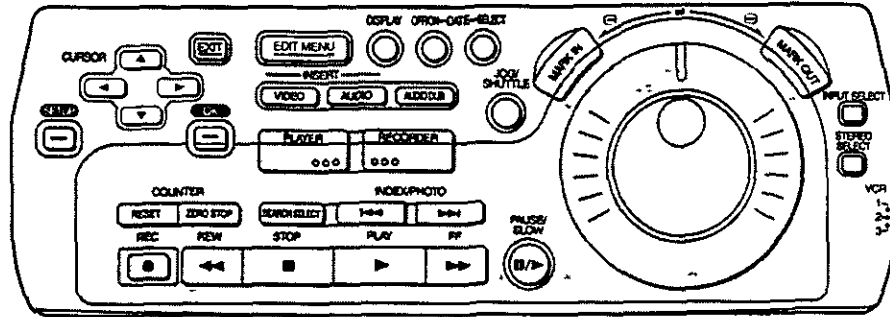

Program Editing

After setting edit start/end points, the actual editing operation may start slightly before or slightly after the position that was set, depending on the equipment that is connected. The procedure described below can adjust the edit timing in order to correct for errors of up to approximately ± 1 second in the edit start points and edit end points on the playback unit.

Example Video Insert

Operations

.....

1 Press **EDIT MENU**.



On Screen Display

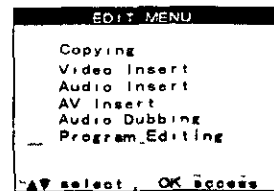

.....

2 Select **Program Editing**, and then Press **OK**.



.....

3 Select desired editing operation, and then press **OK** twice

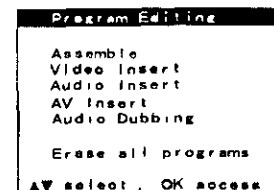
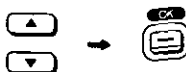

.....

4 Select **Timing Adjust**, and then press **OK**.

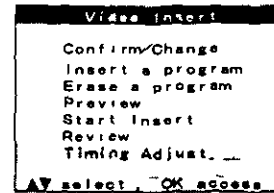

5 Adjust the timing for the edit start point by setting the amount of the discrepancy for the start-up time

- The setting is displayed in frames (approximately 1/30 of a second) units
- Press **▶** if the start point is too early; press **◀** if it is too late.
- Each time the button is pressed, the tape moves by 1 frame
- Corrections can be made in the range of ± 30 frames

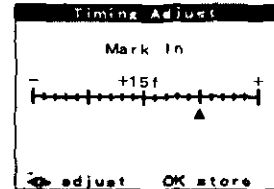

6 Press **OK**.



7 Adjust the timing for the edit end point in same way

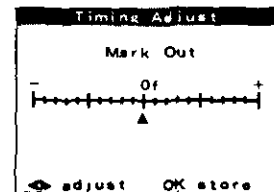

8 Press **OK**.



9 Select **Start Insert (Assemble or Dubbing)**, and then press **OK**.

- If the results of editing indicate that the adjustment is inadequate, repeat steps 4-8.

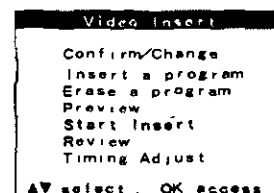
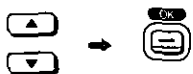

Notes

- The procedure described on these pages is to be performed after exiting the EDIT MENU screen. If this procedure is performed after having executed Start Editing or Review, start this procedure from step 4 on the Video Insert (Assemble, Audio Insert, AV Insert or Audio Dubbing) screen
- The adjusted frame unit is applied to all of the programs that have been set at the moment when the adjustment is made



Edit Timing Adjustment (continued)

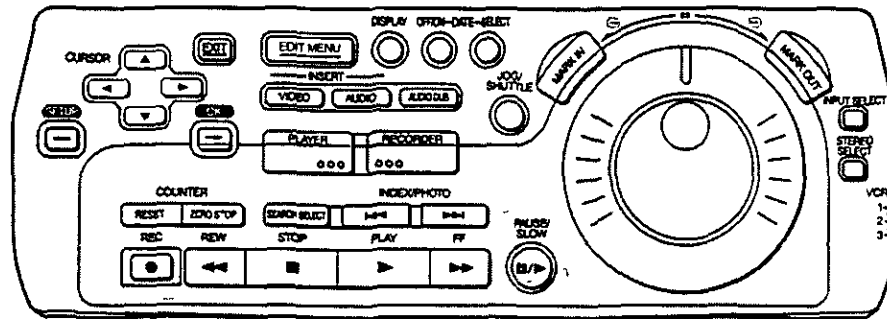

Manual Editing

If there is a deviation in the results of a manual editing operation, the timing of the edit start (In) position on the playback unit can be adjusted by approximately ± 1 second. Perform the procedure described below when setting an edit start point in any editing mode.

Example Manual Copying

Operations

.....

1 Select **Timing Adjust**, and then press **OK**.

.....

On Screen Display

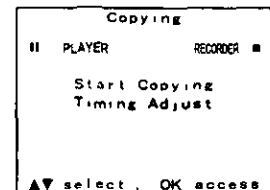

2 Adjust the timing for the edit start point by setting the amount of the discrepancy for the start-up time.

- The setting is displayed in frames (approximately 1/30 of a second) units

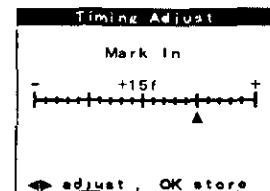

Press **▶** if the start point is too early; press **◀** if it is too late.

- Each time the button is pressed, the tape moves by 1 frame
- Corrections can be made in the range of ± 30 frames

.....

3 Press **OK**.

.....

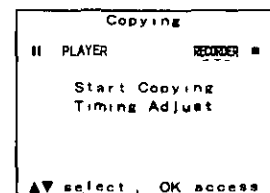

4 Select **Start Copying (Insert, Dubbing)**, and then press **OK**.

- If the results of editing indicate that the adjustment is inadequate, repeat steps 1-3

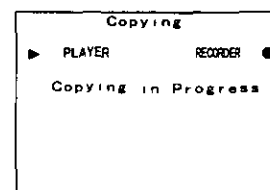



Glossary of Terms

Assemble

With the Assemble function, only the required portions of the original (source) tape are copied to another tape and linked together

Audio Dubbing

You can record two audio tracks (Stereo 1 and Stereo 2) on a tape that is recorded in 12bit audio mode (When the tape is first recorded, the audio is recorded only in the Stereo 1 track) The Audio Dubbing function allows you to add new, separate audio in the Stereo 2 track

Audio Mixing

You can record two audio tracks (Stereo 1 and Stereo 2) on a tape that is recorded in 12bit audio mode (When the tape is first recorded, the audio is recorded only in the Stereo 1 track) The Audio Mixing function allows you to mix the original audio from Stereo 1 with new audio from a line input and record the result in the Stereo 2 track

Copying

The Copying function copies material previously recorded on one tape onto another tape with no changes

Insert

The Insert function allows you to insert different material into previously recorded video or audio. There are three variations of the Insert function: Video Insert, which inserts video only, Audio Insert, which inserts audio only, and AV Insert, which inserts both audio and video

SP/LP Mode

There are two different tape speed modes for digital video: SP and LP

"SP" is short for "Standard Play", and "LP" is short for "Long Play"

LP mode permits recording for about 1.5 times as long as SP mode. Although the image quality of LP mode is as good as that of SP mode, material recorded in LP mode may not play back normally when played on a different video unit, or when played in slow motion or frame by frame, which can result in mosaic noise on the display. In addition, the Insert, Audio Dubbing, and Audio Mixing functions cannot be used with a tape that was recorded in LP mode

- When a cassette recorded in LP mode on this VCR is played back on other digital video equipment
- When a cassette recorded in LP mode on other digital video equipment is played back on this VCR
- When a cassette recorded in LP mode on this VCR is played back on other digital video equipment not featuring LP mode
- When a cassette recorded in LP mode on this VCR is played back on other digital video equipment

Digital Video System

In the digital video system, picture and sound are converted into digital signals and recorded onto tape

This completely digital recording allows recording and playback of picture and sound with minimum quality deterioration

In addition, such data as Time Code, Date and Time are also automatically recorded as digital signals

Features

- Superior picture resolution
- Excellent signal-to-noise ratio
- Stable pictures
- Minimised quality deterioration in dubbing
- Minimised cross color distortion
- PCM digital sound
- No picture deterioration in LP Mode
- 6 35 mm-wide tape
- Compact cassette with long recording time
- Minimised quality deterioration in editing
- Time Code editing

PCM Sound

For recording of the sound, Digital Video Cassette Recorder offers the choice between two different PCM Audio Recording Mode

- 16 bit 48 kHz 2 channels
- 12 bit 32 kHz 4 channels

The "16bit, 48 kHz, 2 channels" mode offers superior recording sound quality

The "12bit, 32 kHz, 4 channels" mode lets you record the original sound on two channels and the dubbed sound on two separate channels

Sub Code

The digital recording system offers the added capability of recording sub code containing various data

The following data is recorded as sub code on the Digital Video Cassette Recorder

- Time Code
- Recording date and time
- Index signals for locating the still images recorded in the Photoshot Mode
- Index signals for locating the beginning of scenes marked with an index signal



DV Terminal

This terminal is used to input/output video and audio data on digital video equipment. Because the video and audio data is sent through the DV cable as digital signals, there is practically no deterioration in video and audio quality after copying. In addition, because the hardware automatically determines the direction of flow for input and output signals according to the state of the unit, there is no need to change the connections around when switching between input and output, as is the case with conventional AV cables. In addition, the DV terminal on this unit can also send control signals that are required in editing operations. If a Panasonic Digital Video Camera is used as the playback unit, only one DV cable needs to be connected between the camera and this unit in order to perform the following editing functions:

Copying, Assemble, Video Insert, and Audio Insert
(Such a configuration does not permit AV insert, Audio Dubbing, or Audio Mixing. AV cables must also be connected.)

The following functional differences exist when the recording unit and the playback unit are connected through the DV terminal, as opposed to when they are connected through the audio and video sockets:

- The original sub code data (date of the recording, photoshot index signals, etc.) on the playback unit is copied as is on the recording unit (Time codes are not copied.)
- The audio is recorded in the same mode (12bit or 16bit) on the recording unit as it was on the playback unit. (If you want to change the audio recording mode, the units must be connected through the audio and video sockets, not the DV terminal.)
- No audio is output while searching with the Jog Dial/ Shuttle Ring.
- The AV-IN Color Level and the AV-IN Hue Level settings on the SET UP menu are not available.
- When playing a tape that was recorded with two audio channels (main and sub, from a bilingual broadcast, for example), both the main audio channel and the sub audio channel are output, regardless of the audio select (main/sub) setting.
- Horizontal sway may appear at the bottom of the screen for video input from the DV terminal, but this has no effect on the recording.

Time code

Time codes are time data that is recorded on a tape. The time is expressed in units of hours (h), minutes (m), seconds (s) and frames (f). (One second is equivalent to approximately 30 frames.) Time codes are recorded concurrently while video is recorded. If a recording is made continuously from the beginning of a tape, the time codes can be used to determine the absolute position of video and audio recorded on the tape.

When you first record on a brand new (completely blank) cassette, the time codes are also recorded, starting from zero. If you start recording in the middle of a cassette that has already been partially recorded, and you start where the previous recording ended, the time code values continue from the ending value of the previous recording. However, if you start recording in the middle of a tape after a blank section of tape, the time codes again start from zero. Because one frame is equivalent to approximately 1/30 of a second, if you record continuously for an extended period of time, a slight discrepancy will eventually arise between the time codes and the actual duration of the recording. In the digital video SD standard, compensation for this discrepancy between the time codes and the actual duration is applied by using the drop frame method. (Refer to the explanation of Drop frames.)

Drop Frame

Because one frame (f) in NTSC Time codes is equal to 1/30 of a second, recording continuously for an extended period of time will result in a slight discrepancy between the time codes and the actual duration of the recording. The drop frame method automatically compensates for this discrepancy by skipping frame 00 and frame 01 at the 00 second mark of every minute, except for the 0, 10, 20, 30, 40, and 50 minute marks.

Frame

Movement in a video image is produced through a series of successive still images in the same manner as a movie. In a video, there are 30 stills per second, one still is called a "frame." In the NTSC format, one frame of the time code is equivalent to approximately 1/30 of a second.

Tape Counter (Linear counter)

This counter mode is used to display the elapsed recording or playback time. Because the value that is displayed is derived from the length of tape travel, it is not possible to display the precise tape position, as it is with time codes. When a cassette is loaded, the counter is reset to "0 00 00". The counter can also be reset to "0 00 00" at any position simply by pressing **RESET**. You can keep track of the elapsed recording or playback time by resetting the counter when you start recording or playback.



On Screen Display Messages

Before requesting service, check the following points once again

The error message is indicated in brackets []

[Please insert video tape]

- ☞ **REC**, **▷ (PLAY)**, **▶▶ (FF)**, **◀◀ (REW)** or **JOG/SHUTTLE** is pressed when no cassette is in the VCR
Insert a video cassette

[Recording not allowed Check setting of the record-prevention tab]

- ☞ **REC**, **VIDEO INSERT**, **AUDIO INSERT** or **AUDIO DUB** has been pressed when using a cassette with the opened record-prevention tab Use a cassette with a closed record-prevention tab

[This function cannot be made in the blank part of the tape]

- ☞ Are you trying to edit using a blank tape, or a tape that contains a blank segment in the middle?
Editing is not possible in blank segments (because there are no Time codes) In order to use such a tape for editing, copy the tape once so that continuous Time codes are recorded on the tape, even if there is nothing else recorded on the tape See page 33

[This function is not allowed in LP-recorded section of the tape]

- ☞ It is not possible to edit a tape that was recorded in LP mode, or that was recorded partly in SP mode and partly in LP mode Make a copy of the tape in SP mode and then use that tape See page 33

[This function cannot be made with 16bit mode audio recording]

- ☞ Does the audio mode change in the middle of the tape?
The Audio Dubbing and AV Insert functions can only be used on a tape that was recorded in 12bit audio mode Make a copy of the tape in 12bit mode and then use that tape See page 33

[EDITING cannot be made Please check switches setting and cables]

- ☞ Are the necessary cables for controlling the playback unit (Edit cable or DV cable) connected?
Connect cables for controlling
- ☞ Is the playback unit turned off?
- ☞ Are **EDIT MODE**, **EDIT CONTROL**, and the input select setting on this VCR set properly for the desired editing operation?
- ☞ Is there more than one digital video device (including personal computers) connected to this VCR?
- ☞ Are this VCR and another unit connected to this VCR both set to control each other (if the connected unit is a digital video device)?

[Audio Dubbing or Audio Mixing cannot be made with DV input mode]

- ☞ Audio Dubbing and Audio Mixing functions will not work if **INPUT SELECT** is set to DV IN
Set to A1 or A2

[AV Insert cannot be made with DV input mode]

- ☞ AV Insert will not work if **INPUT SELECT** is set to DV IN Set to A1 or A2

[Please select DV input mode]

- ☞ Is **EDIT CONTROL** set to DV, but **INPUT SELECT** is set to something other than DV IN?

[This tape is an incorrect type Please replace the tape]

- ☞ A video cassette tape other than a DV or MINI DV cassette has been inserted
DVCPRO cassettes cannot be used with this VCR

Other messages may also appear
Follow the instructions in the message





Before Requesting Service

Before requesting service, check the following points once again

Self Test Indication

This VCR has a self-diagnosis and display function. If the VCR detects trouble during installation or during use, the following indications automatically appear in the VCR display. Indications are displayed in the form of a single English letter plus two numbers such as [H01].

INDICATION

H □□

F □□



CAUSE

Some problem has occurred

(Numbers following H and F differ according to the status of the VCR.)



REMEDY

Consult your dealer for further advice

VCR does not operate correctly

The symptom description is indicated in quotations " "

"VCR display is not illuminated"

- ☛ Mains lead is not connected. Reconnect mains lead to VCR.

"VCR picture does not appear on monitor screen"

- ☛ The connections are incorrect. Check the connections with the monitor.

Playback does not operate correctly

The symptom description is indicated in quotations " "

"The playback picture contains rectangular blocks of picture noise or the whole screen becomes black"

- ☛ Video heads are clogged or worn. Use the Digital Video Head Cleaner supplied with the VCR. (See page 74.) If the picture is still not clear after using it, consult your dealer for further advice.

Recording does not operate correctly

The symptom description is indicated in quotations " "

"[RECORD] indication flashes whenever recording is attempted"

- ☛ The record prevention tab on the cassette is open. Close the record prevention tab. (Slide it in the direction of the [REC] arrow.)

"Recordings cannot be made"

- ☛ Does **INPUT SELECT** setting match the sockets that are actually connected?
- ☛ The connections are incorrect. Check that connections for external video and audio source are correct. See page 13.

Remote controller does not work correctly

The symptom description is indicated in quotations " "

"Remote controller does not operate correctly"

- ☛ Remote controller transmitter beam is not reaching the VCR. Ensure that remote controller is being pointed at the VCR and that the transmitter beam is not obstructed.
- ☛ Distance is too far. Use remote controller within 7 m of the VCR. If operation is not possible in this range, replace the batteries.
- ☛ Batteries are spent. Replace the batteries. Note the precautions for replacement on page 11.
- ☛ Batteries are incorrectly fitted with (+/-) reversed. Fit the batteries correctly as shown on page 11.
- ☛ Wrong remote control mode has been selected. Set to the correct remote control mode. (See page 20.)

Editing does not operate correctly

The symptom description is indicated in quotations “ ”

“One-Touch-Editing does not work”

- ☛ Is **One-Touch-Edit** on the SET UP screen set to “ON” ?

“Editing does not commence, the VCR stays in the recording pause state”

- ☛ While setting the edit start point on the playback unit, this VCR switched from the recording pause state to the stopped state
- ☛ In order to protect the tape and the head from damage, this VCR is designed to automatically stop if it is left in the recording pause state for more than 5 minutes

“The picture from the playback unit is not appeared”

- ☛ Does **INPUT SELECT** setting match the sockets that are actually connected?
- ☛ Are the cables connected to the playback unit securely?

“Cannot execute the editing operation, or the operation stops suddenly before it is complete”

- ☛ The following are possible causes
 - There is a blank segment in the middle of the tape in the recording unit
 - The tape speed (SP/LP) or the audio mode (12bit/16bit) changed in the middle of the tape in the recording unit
 - The end of the tape was reached in the VCR
 - The VCR was suddenly not able to control the connected unit
 - The tape that is being used either does not contain continuous Time codes, or contains two identical Time codes
 - The Input select setting or **EDIT CONTROL** was changed while editing was still in progress
 - An edit start/end point was set within 20 seconds of the beginning of the tape

“The EDIT MENU screen does not appear, even though EDIT MENU has been pressed”

- ☛ **EDIT CONTROL** is set to **OFF**
- ☛ This unit is set as indicated below in the following instances
 - With **EDIT CONTROL** set to **DV**, is **EDIT MODE** set to **PLAYER** or **PASSIVE?** (when two AG-DV2000s are connected)
 - With **EDIT CONTROL** set to **EDIT**, is **EDIT MODE** set to **PASSIVE?**

“Control of the playback unit was lost while editing was in progress”

- ☛ If the playback unit is left in the pause state for more than 5 minutes, it may automatically stop in order to protect the tape and the head from damage
- ☛ If the playback unit is a video camera, control is not possible if the camera is in CAMERA Mode. Put the camera into PLAYBACK (VCR) Mode

“Program Editing is not available for selection on the EDIT MENU screen”

- ☛ Program Editing is not available if the playback unit that is connected does not have a Time code or tape (linear) counter display

“After setting the edit start/end points, the next screen does not appear when OK is pressed”

- ☛ Have all three points in the edit start/end points been set on the playback unit and the recording unit? Program setting is not completed unless 3 or more points are set
- ☛ Are the edit start/end points set in the wrong order (i.e., the editing end precedes the in point)?

“Cannot set program”

- ☛ Have the maximum number of programs already been set?

“A set program is skipped”

- ☛ Are there at least 4 seconds between the edit start point and the end point?
- ☛ Editing may not be performed properly for a program with a set duration of less than 4 seconds

“Cannot adjust the edit timing”

- ☛ The edit timing cannot be adjusted if the playback unit that is connected does not have a Time code or tape (linear) counter display



Flow Chart for On Screen Displays

SET UP On Screen Display

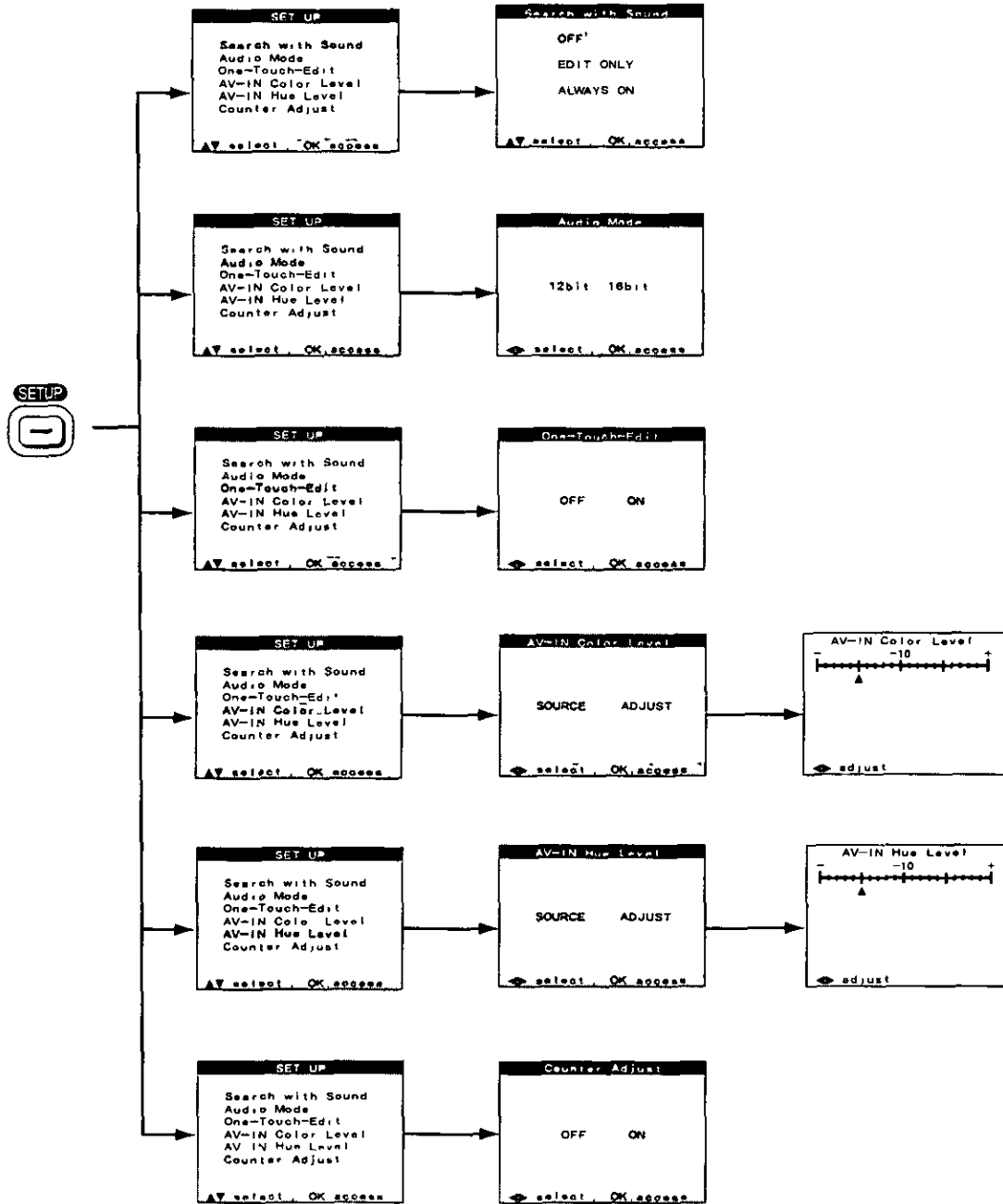

EDIT MENU On Screen Display (Manual Editing)

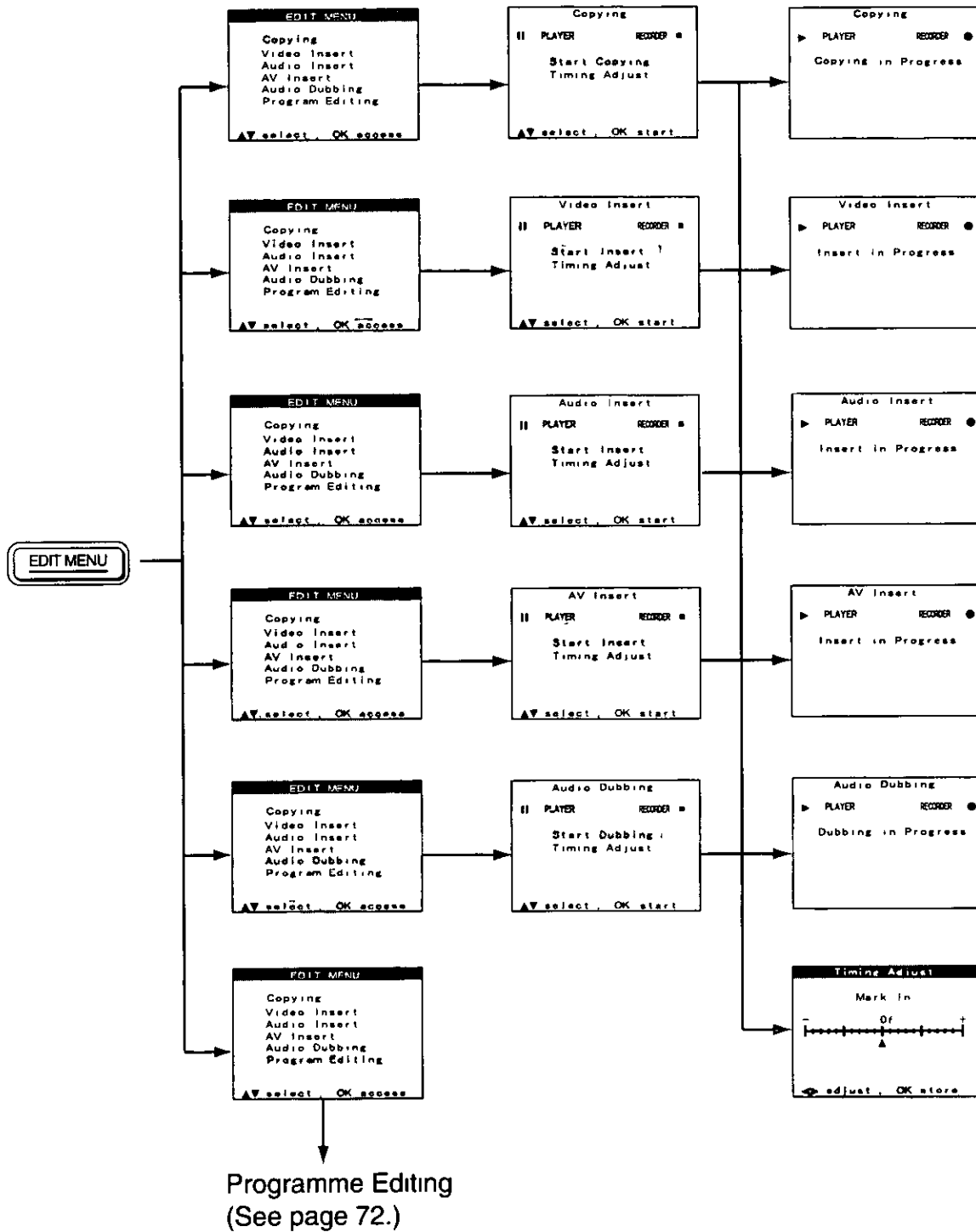

Flow Chart for On Screen Displays (continued)

Program Editing On Screen Display

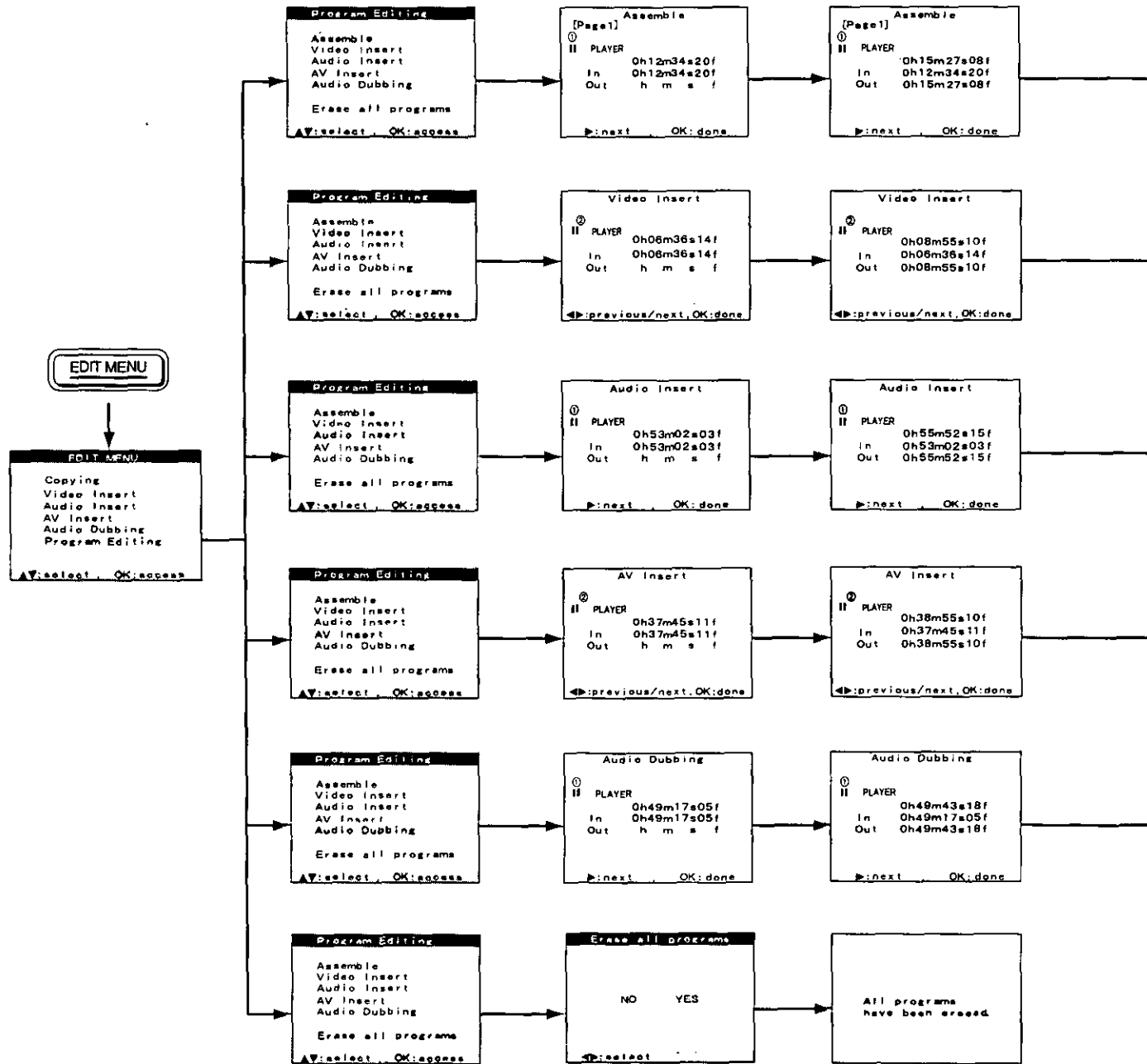

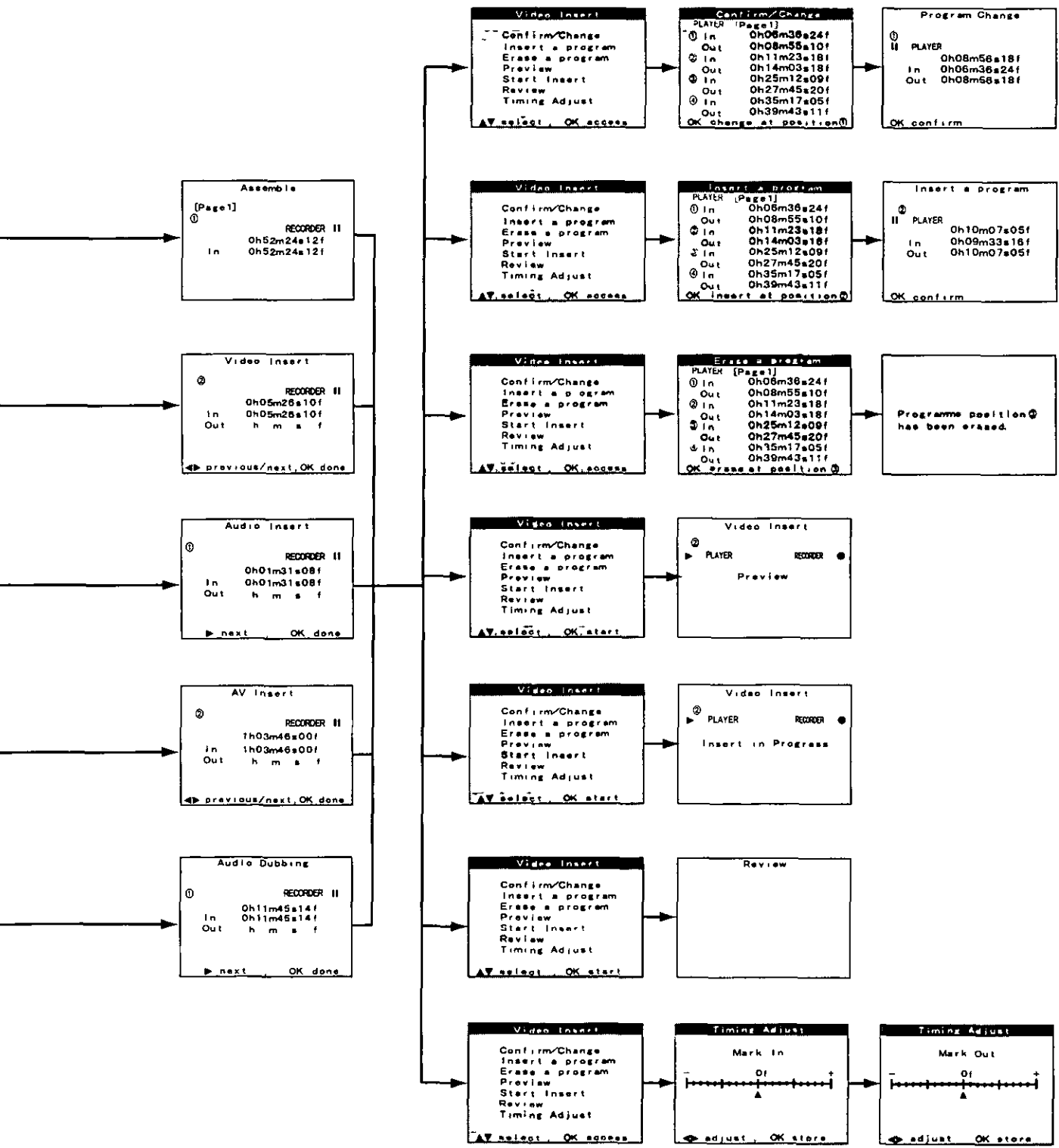

Helpful Hints





Usage Precautions

Please read these precautions before operating this VCR

Avoid Sudden Changes in Temperature

If the VCR is suddenly moved from a cold place to a warm place, condensation may form on the tape and inside the VCR. In this case, the "d" dew indicator will flash on and off and the VCR will not operate.

Humidity and Dust

Avoid places where there is high humidity or much dust. This may cause damage to the internal parts.

Do Not Obstruct the Ventilation Holes

The ventilation holes prevent abnormal increases in temperature. Do not block or cover these holes. Particularly avoid covering the holes with soft materials such as cloth or paper.

Avoid High Temperatures

Keep the VCR away from sources of extreme heat such as direct sunlight, radiators, or closed automobiles.

Avoid Magnets or Magnetized objects

Never bring a magnet or magnetized object near the VCR. It will adversely affect the performance of the VCR. Keep the VCR away from other equipment as much as possible when using it, to avoid any adverse effect on performance of both the VCR and the other equipment.

Do Not Place Fingers or Other Objects Inside

Touching internal parts of this VCR is dangerous and may cause serious damage to the VCR. Do not attempt to disassemble the VCR. There are no user serviceable parts inside.

Keep Water Away

Keep the VCR away from flower vases, tubs, sinks, and other locations where it could come into contact with water. **CAUTION** If liquids are spilled into the VCR, serious damage could occur. If this happens, consult qualified service personnel.

Lightning

To avoid damage by lightning, disconnect the aerial plug from the VCR during lightning storms.

Cleaning the VCR

Wipe the VCR with a clean, dry cloth. Never use cleaning fluid or other chemicals. Also do not use compressed air to remove dust.

Stacking

Place the VCR in a horizontal position, and do not place anything heavy on top of it.

Video Head Clogging and Remedy

When the video heads (which contact the tape) are dirty, the playback picture contains mosaic-like patterns or the whole screen becomes black. If they become even more dirty, the recording performance deteriorates and in the worst case, recording may not be possible at all.

Causes of Dirty Video Heads

- A lot of dust in the air
- High-temperature and high-humidity environment
- Damaged tape
- Long-time use

Using the Mini-DV Format Digital Video Head Cleaner

- 1 Insert the Head Cleaner into the VCR in the same way as a video cassette.
- 2 Press **▷ (PLAY)**, and after approximately 20 seconds press **□ (STOP)** (Do not rewind the tape.)
- 3 Take out the Head Cleaner. Insert a video cassette, perform recording and then play it back to check the picture.
- 4 If the picture is still not clear, repeat above operation steps 1-3 (Do not use the Head Cleaner more than 3 times in succession.)

Notes

- Do not rewind the tape in the Head Cleaner after every use. Rewind it only after the tape has reached its end, and then use it again in the same way from the beginning.
- If the video heads again become clogged with dirt soon after cleaning, this might be caused by a damaged tape. In this case, stop using that cassette immediately.
- Be careful not to clean the video heads too much (Too much cleaning could cause excessive wear to the video heads. If the video heads get worn, the picture is not played back clearly even after cleaning.)
- If using the Head Cleaner does not clear the video head clogging, the VCR requires cleaning or repairing by a service center. Please consult with your dealer.
- This Video Head Cleaner is available from service centers.

Dew May Form in the VCR if:

- The VCR is in a room where the heater has just been turned on
- The VCR is in a room with steam or high humidity
- The VCR is brought from cold surroundings into a heated room
- The VCR is suddenly brought from cool surroundings, such as an air-conditioned room or car, to a place which is hot and humid

When dew forms in the VCR, the “d” dew indicator on the display flashes on and off (The self test indicator “U10” will also appear in the VCR display) and all the function buttons are made non-operational to protect the tape and the video heads. When the dew indicator flashes, wait until this indicator disappears.

- If dew forms inside the VCR while the VCR is off, it will turn on automatically and the dew indicator will flash on and off. As soon as the dew disappears, the VCR will turn itself off again.

Note:

Do not operate the VCR for at least 1 hour if any of the above conditions occur





Specifications

AG-DV2000P

Power Source	120 V AC 60 Hz
Power Consumption	27 watts
Power Consumption When in Standby Mode	Approx 7 watts

Video Recording System	2 rotary heads, Digital Component		
Audio Recording System	PCM Digital Recording, 16 bit (48 kHz/2ch), 12 bit (32 kHz/4ch)		
Video Heads	2 heads		
Tape Speed	SP, 18 812 mm/sec		
	LP, 12 555 mm/sec		
Tape Format	DV/ Mini DV tape		
Record/Playback Time	SP, 120 min LP, 180 min with DV120		
	SP, 60 min LP, 90 min with DVM60		
FF/REW Time	approx 70 sec with DV120		
	approx 50 sec with DVM60		

VIDEO

Television System	EIA, Standard (525 lines, 60 fields) NTSC color signal		
Modulation System	Digital Component recording		
Input Level	VIDEO IN,	1.0 Vp-p,	75 ohm, terminated
	S-VIDEO IN,	1.0 Vp-p,	75 ohm, terminated
Output Level	VIDEO OUT	1.0 Vp-p,	75 ohm, terminated
	S-VIDEO OUT	1.0 Vp-p,	75 ohm, terminated

AUDIO

Input Level	AUDIO IN	309 mV,	more than 47 kohm
	MIC(M3),	0.33 mV,	600 ohm
Output Level	AUDIO OUT	309 mV,	less than 1 kohm
	HEAD PHONES,	1-30 mV,	8 ohm

Audio Track	16 bit (48 kHz/2ch),	1 track, 2 channels
	12 bit (32 kHz/4ch),	2 tracks, 4 channels

Digital Interface:	DV Terminal (i LINK, 4-pin)		
Video Horizontal Resolution	Color, more than 500 lines		
Audio Frequency Response	20 Hz-20 kHz (16 bit)		
	20 Hz-14.5 kHz (12 bit)		
Operating Temperature	5°C-40°C		
Operating Humidity	35%-80%		
Weight:	14.6 lbs (6.8 kg)		
Dimensions	17 ⁹ / ₁₆ "(W)×4 ⁷ / ₈ "(H)×13 ⁷ / ₈ "(D) [445 (W)×123 (H)×351.5 (D) mm]		

Weight and dimensions shown are approximate
Specifications are subject to change without notice

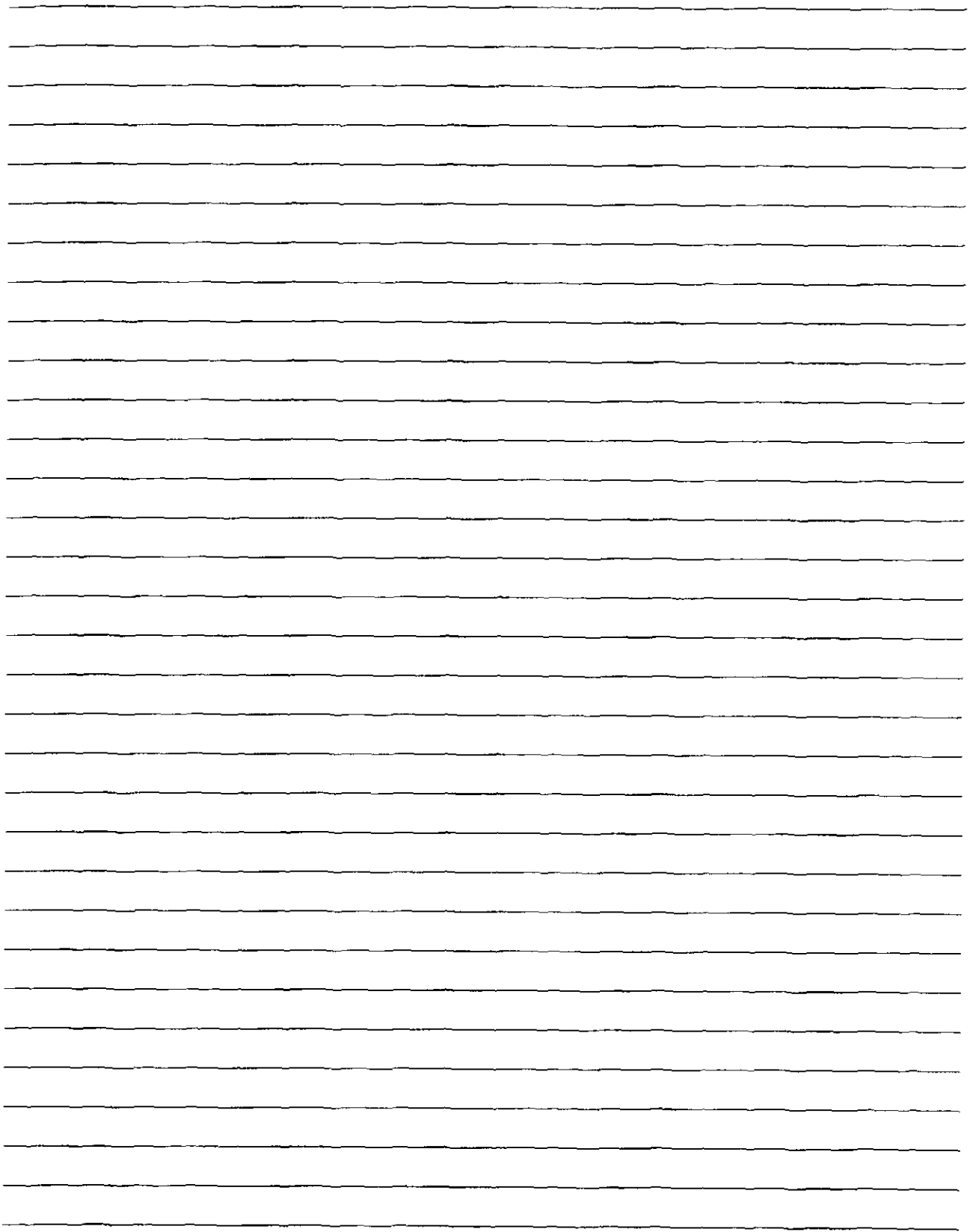

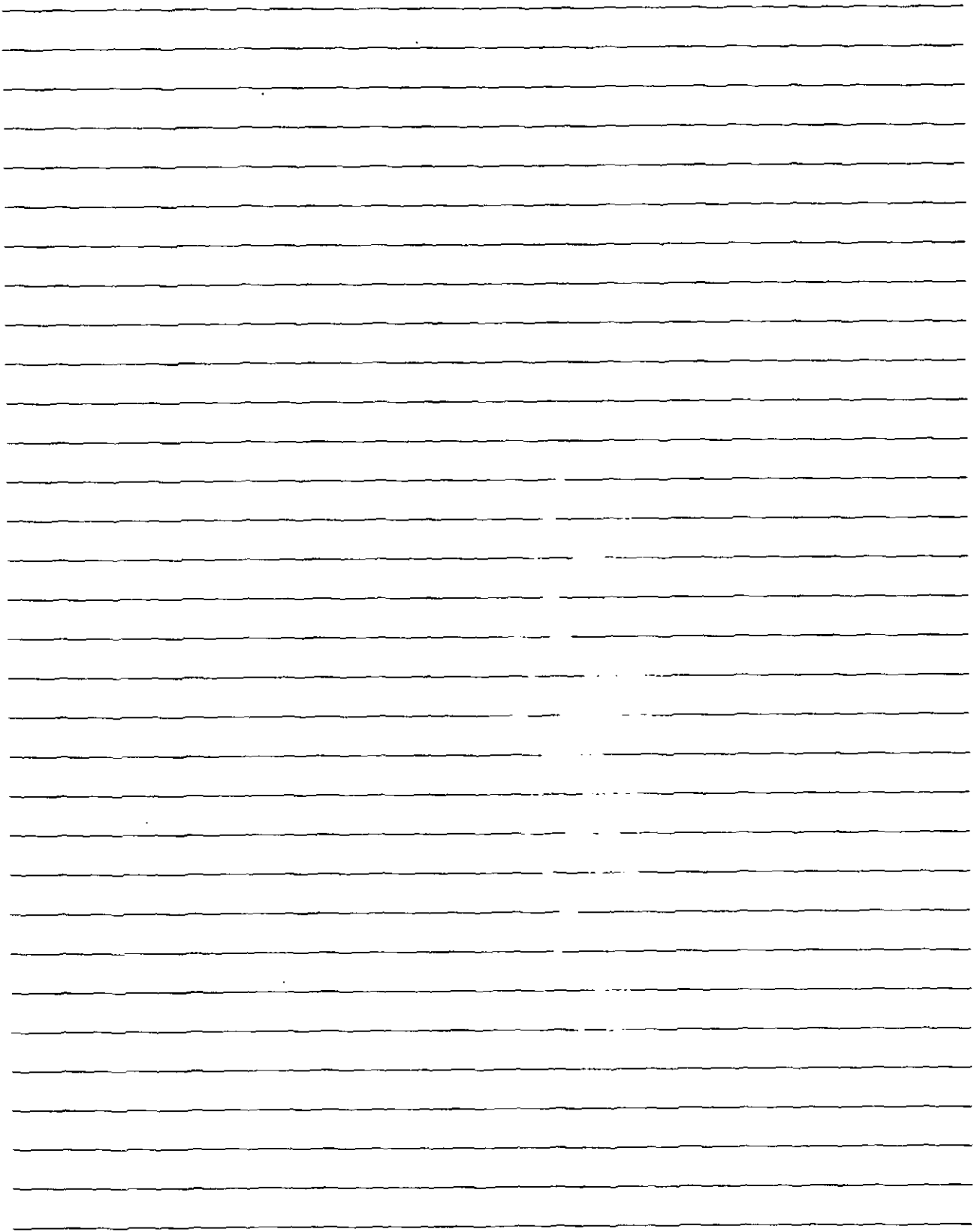

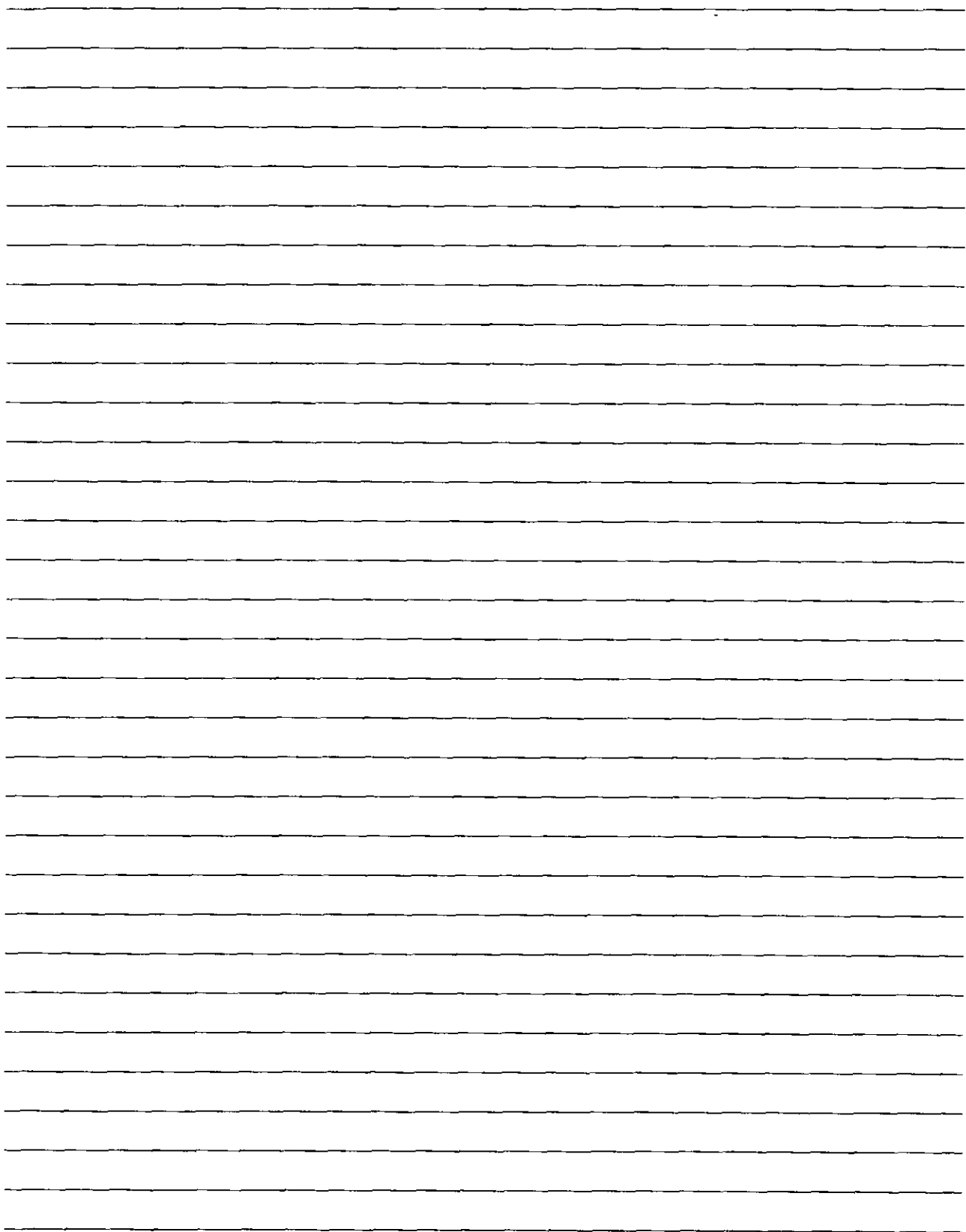

Panasonic

Broadcast & Television Systems Company

Division of Matsushita Electric Corporation of America

Executive Office

One Panasonic Way (4B-7), Secaucus, NJ 07094

Service Centers

Eastern

One Panasonic Way, Panazip (2A-4), Secaucus, NJ 07094
(201)-348-7677 Fax (201)-348-7511

Southern.

1225 Northbrook Parkway, Suite #170, Suwanee, GA 30174
(770)-338-6855 Fax (770)-338-6656

Western

4001 West Alameda Ave , Suite 100, Burbank, CA 91505
(818)-562-1579 Fax (818)-562-6663

Parts Information & Ordering

9 00 am – 5 00 pm (EST) (800)-334-4881/24 hr Fax (800)-334-4880

Technical Support

Emergency 24 hr Parts & Support (800)-222-0741

Training Information

Digital System Products (201)-392-6076

Service Literature

(201)-392-6281

Panasonic Canada Inc

5770 Ambler Drive, Mississauga, Ontario L4W 2T3 (905)-624-5010

Panasonic de Mexico S A de C V

Av angel Urraza Num 1209 Col de Valle 03100 Mexico, D F (52) 1 951 2127



Printed in USA



F1198C0 (3000A)

